



VTT Technical Research Centre of Finland

## A review of aeronautical fatigue investigations in Finland May 2009 - March 2011

Peltoniemi, Enna; Siljander, Aslak

Published: 01/01/2011

*Document Version*  
Publisher's final version

[Link to publication](#)

*Please cite the original version:*

Peltoniemi, E., & Siljander, A. (Eds.) (2011). *A review of aeronautical fatigue investigations in Finland May 2009 - March 2011*. VTT Technical Research Centre of Finland. ICAF National Review - Finland No. 2427VTT Research Report No. VTT-R-02827-11

VTT  
<https://www.vttresearch.com>

VTT Technical Research Centre of Finland Ltd  
P.O. box 1000  
FI-02044 VTT  
Finland

By using VTT Research Information Portal you are bound by the following Terms & Conditions.

I have read and I understand the following statement:

This document is protected by copyright and other intellectual property rights, and duplication or sale of all or part of any of this document is not permitted, except duplication for research use or educational purposes in electronic or print form. You must obtain permission for any other use. Electronic or print copies may not be offered for sale.

**A REVIEW OF AERONAUTICAL FATIGUE  
INVESTIGATIONS IN FINLAND  
MAY 2009 – MARCH 2011**

Presented at the 32<sup>nd</sup> Conference of the  
International Committee on Aeronautical Fatigue and  
Structural Integrity (ICAF),  
Montréal, Canada, 29-31 May 2011

Compiled by

Enna Peltoniemi; Aslak Siljander

Confidentiality

Public

## Preface

The Finnish Air Force Materiel Command (FINAFMC), Programmes Division, initiated and supported this work. The editors are indebted to the following individuals who helped in the preparation of the review (organizations and individuals in alphabetical order – the reference list refers to paragraph-specific contributions):

Aalto	<i>Aalto University, School of Engineering, Department of Applied Mechanics, Aeronautical Engineering:</i> Jarkko Aakkula, Olli Saarela, Markus Wallin;
Emmecon	<i>Emmecon Ltd:</i> Risto Hedman;
FINAFMC	<i>Finnish Air Force Materiel Command, Programmes Division:</i> Ari Kivistö, Markus Mecklin, Antti Mäkinen, Kari Renko, Kalle Vaaraniemi, Ari Välikangas; <i>Finnish Air Force Materiel Command, Plans Division:</i> Henry Paajanen; <i>Finnish Air Force Materiel Command, Aircraft Division:</i> Jukka Taattola;
FINAFFTC	<i>Finnish Air Force, Flight Test Center:</i> Raimo Enberg, Hannu Heinele, John Öström;
FINAFSAC	<i>Finnish Air Force, Satakunta Air Command:</i> Peter Ylinen;
Finflo	<i>Finflo Ltd:</i> Juho Ilkko, Esa Salminen, Timo Siikonen;
Millidyne	<i>Millidyne Ltd:</i> Mika Kolari, Petri Sorsa;
Patria	<i>Patria Aviation Oy, RTD &amp; Aeronautical Engineering:</i> Mika Keinonen, Mirve Liius, Janne Linna, Juha Lähteenmäki, Simo Malmi, Antero Miettinen, Mikko Orpana, Jouni Pirtola, Jukka Raunio, Tuomo Salonen, Jaakko Sotkasiira, Maria Stenberg, Piia Stenhäll, Jarkko Tikka; <i>Patria Aviation Oy, Systems/Avionics:</i> Juha Alanko, Jari Koivu, Tini Nieminen, Timo Takala; <i>Patria Aviation Oy, Aircraft, Engines Unit:</i> Jani Simelius; <i>Patria Aviation Oy, Aircraft Halli:</i> Juha Alanko;
TUT/DSP	<i>Tampere University of Technology, Department of Signal Processing:</i> Juha Jylhä, Marja Ruotsalainen, Ilkka Venäläinen, Ari Visa;
TUT/DMS	<i>Tampere University of Technology, Department of Materials Science:</i> Elina Huttunen-Saarivirta, Turi Salomaa, Veli-Tapani Kuokkala, Viivi Pirttiniemi;
TUT/IHA	<i>Tampere University of Technology, Department of Intelligent Hydraulics and Automation:</i> Jussi Aaltonen, Vänni Ala-Rotu, Jukka-Pekka Hietala, Kari T. Koskinen, Tomi Krogerus;
VTT	<i>VTT Technical Research Centre of Finland:</i> Pertti Auerkari, Mika Bäckström, Harri Janhunen, Juha Juntunen, Keijo Koski, Risto Laakso, Kari Lahdenperä, Esa Leskelä, Sauli Liukkonen, Amar Mahiout, Juha Mannila, Sakari Merinen, Juha Nikkola, Tauno Ovaska, Enna Peltoniemi, Juhani Rantala, Eetta Saarimäki, Jorma Salonen, Matti Sarkimo, Jarmo Siivinen, Aslak Siljander, Tuomas Teittinen, Päivi Varis, Juha Veivo, Tomi Viitanen.

Espoo 26<sup>th</sup> April 2011

Editors

## Contents

<b>13.1</b>	<b>Introduction .....</b>	<b>4</b>
13.1.1	Valmet Vinka .....	5
13.1.2	Hawk Mk51/51A and Mk66 .....	7
13.1.3	F-18C/D Hornet.....	7
13.1.4	Scope of the review .....	9
<b>13.2</b>	<b>Current activities: ASIMP 2007-2009 and ASIMP 2010-2012.....</b>	<b>10</b>
13.2.1	Loads and stresses .....	10
13.2.1.1	Computational fluid dynamics (CFD) – update .....	10
13.2.1.2	Flight simulations .....	11
13.2.1.2.1	Trendlines in the fatigue tracking of Hornet flights and damaging maneuvers.....	12
13.2.1.2.2	The analysis of the two Hornet flights in view of wing stressing.....	12
13.2.1.2.3	Trim routine development .....	12
13.2.1.3	Hornet FE modeling – update.....	13
13.2.2	Fatigue tracking systems.....	15
13.2.2.1	FINAF F-18 HOLM jets in routine squadron service .....	15
13.2.2.2	Flight maneuver identification (FMI).....	15
13.2.2.2.1	Flight data driven aircraft usage analysis.....	16
13.2.2.2.2	Flight-maneuver-specific fatigue estimation.....	17
13.2.2.2.3	Flight maneuver FLE compilation.....	17
13.2.2.3	Parameter based fatigue life analysis - update .....	18
13.2.2.4	Adding non-instrumented structural locations into fatigue tracking .....	19
13.2.2.5	The Hawk OLM program.....	20
13.2.2.5.1	Structural-specific life consumption metrics (Hawk) and Kauhava-based flying .....	20
13.2.2.5.2	Towards Hawk Mk.51 Upgrade 2 (UG2) .....	21
13.2.2.6	Research efforts towards an OLM replacement system (Hawk Upgrade 2).....	22
13.2.2.6.1	Structural data acquisition system (ESDA).....	22
13.2.2.6.2	Integrated eddy current inspection system for FINAF Hawks .....	22
13.2.3	Structural integrity of composite materials .....	23
13.2.3.1	Thermographic studies – update .....	23
13.2.3.2	Strength prediction of impact damaged laminates in multiaxial in-plane loading.....	25
13.2.3.3	Fracture mechanics based analysis of delamination.....	25
13.2.4	Structural integrity of metallic materials.....	27
13.2.4.1	Life improvement factor (LIF) of polished and shot-peened titanium alloy 6Al-4V .....	27
13.2.4.2	The effect of the alodine chromate conversion for the aluminum structure fatigue life .....	27
13.2.4.3	FINAF F-18 and Hawk structural integrity manuals.....	27
13.2.4.4	Non-destructive inspection (NDI) activities (metallic materials).....	28
13.2.4.4.1	Experimental study of the sensitivity of the crack detection techniques applicable in the periodic in-service inspections using reference specimens .....	28
13.2.4.4.2	Experimental study of the sensitivity of the crack detection techniques applicable in the periodic in-service inspections using unpainted and painted test specimen with real fatigue cracks. 29	29
13.2.5	Repair technologies .....	31
13.2.5.1	Repair technologies for the FINAF F-18 metallic primary structures .....	31
13.2.5.1.1	Proof-of-concept demonstration in laboratory conditions.....	31
13.2.5.1.2	Cure cycle testing of boron fiber patch (on-aircraft installation) .....	32
13.2.6	Mechanical systems integrity .....	33
13.2.6.1	Simulation and modeling.....	34
13.2.6.2	Laboratory and field testing.....	34
13.2.6.3	Condition control and monitoring.....	35
13.2.7	Engine integrity.....	35
<b>13.3</b>	<b>Related activities .....</b>	<b>36</b>
13.3.1	From one-seater to two-seater successfully modified (HN-468) but then lost.....	36
13.3.2	Environmentally friendly corrosion protection studies .....	36
<b>13.4</b>	<b>References .....</b>	<b>38</b>

## 13.1 Introduction

The year 2011 marks the 93<sup>rd</sup> anniversary of the Finnish Air Force (FINAF) – one of the oldest independent air forces in the world. It was founded as an independent service on the 6<sup>th</sup> March 1918 / 4/. The fixed wing aircraft inventory of the FINAF at the time of writing this review is summarized in **Figure 1**. The FINAF ordered six (6) Pilatus PC-12 NG liaison aircraft (single-engine turboprops) from Pilatus Aircraft Ltd in the spring of 2009. The first two aircraft were received on 8 July 2010. In contrast to the information in ICAF 2009, the FINAF received all of the purchased Pilatus PC-12 NG's in 2010, ahead of the initial schedule. The third C-295M will be received in 2011. The new PC-12 NG aircraft have replaced the six twin-engine Piper Chieftains which were 25 years in FINAF operation. Ten (10) Valmet Redigos will be retired, one by one, by the year of 2013 / 5/.

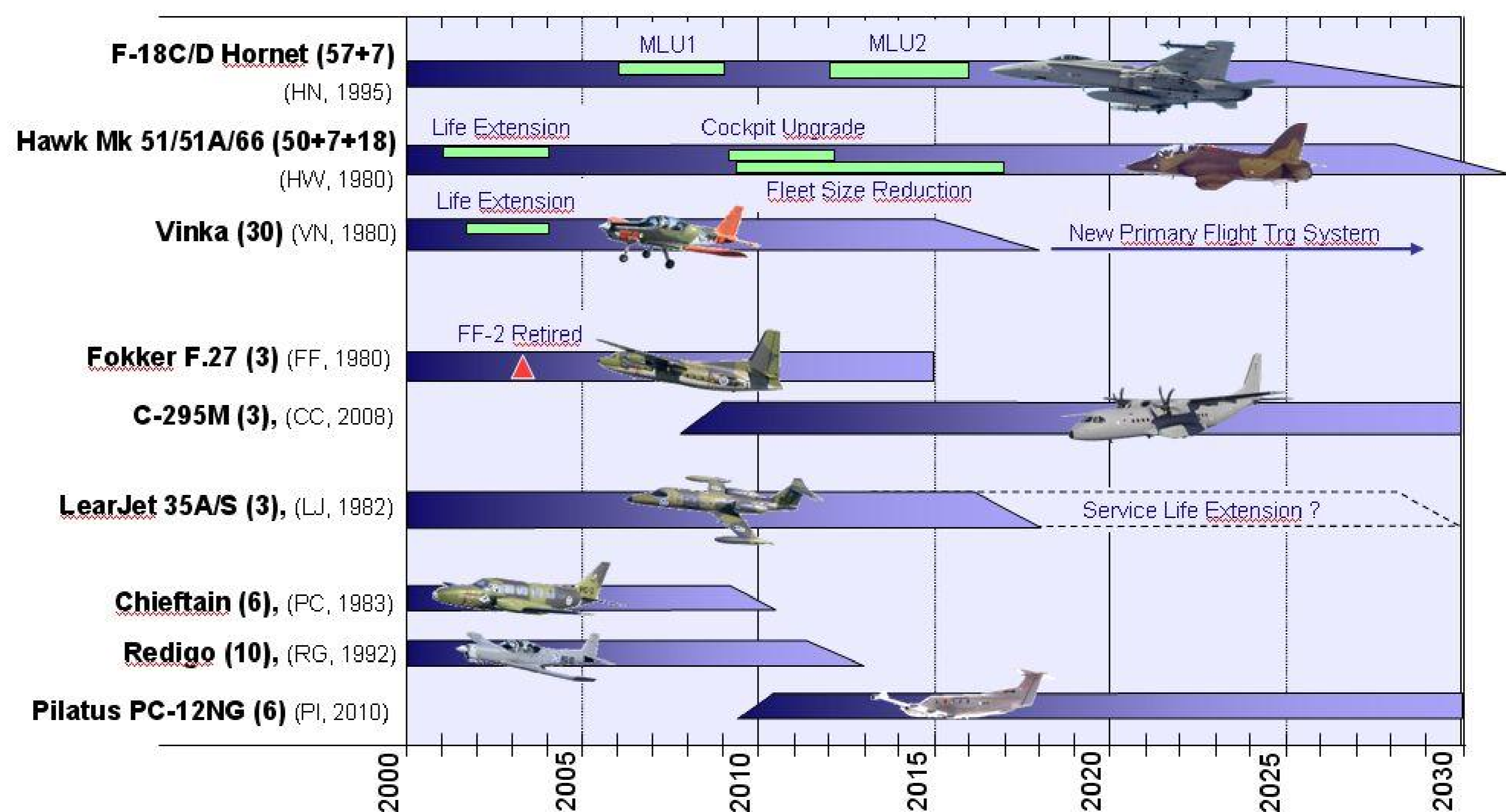

**Figure 1:** An overview of the fixed wing aircraft inventory of the Finnish Air Force (FINAF). Picture by courtesy of the FINAF.

By the end of year 2010, of the 20 TTH/SAR NH90 helicopters purchased by the Finnish Defence Forces (FDF), a total of 9 helicopters have been delivered by Patria. Five of the received NH90's are in initial operational configuration (IOC) and four in IOC+ configuration. The rest of the NH90s will be delivered in future and those helicopters correspond to the full operational configuration (FOC), while those NH90s delivered earlier (IOC+) will be upgraded to the FOC / 52/ / 7/. The helicopters of the FDF at the time of writing this review are summarized in **Figure 2**.

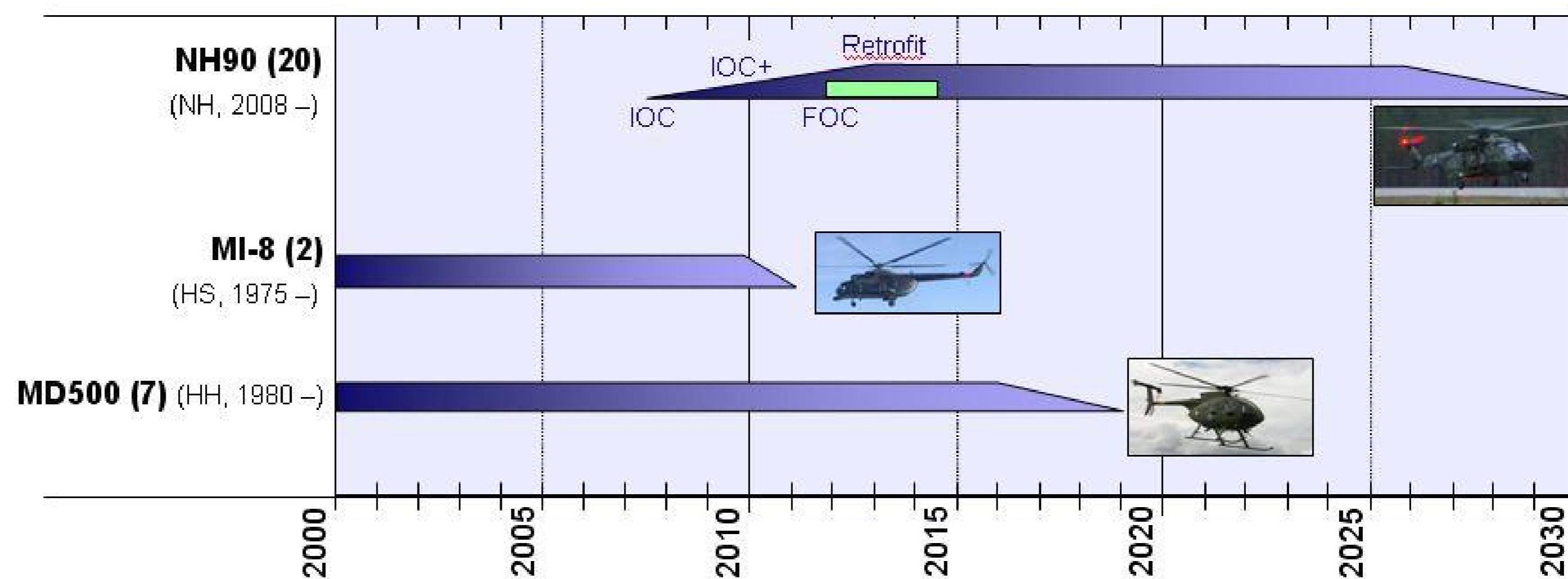

**Figure 2:** An overview of the rotary wing aircraft inventory of the Finnish Defence Forces (FDF). Picture by courtesy of the FDF.

Before going into highlights of the structural integrity management activities, a brief update of the FINAF's fighter aircraft and associated pilot training aircraft is provided below.

### 13.1.1 Valmet Vinka

Previous activities related to the Valmet Vinka primary trainer of the FINAF were outlined in e.g. ICAF 2009 Chapter 13.1.1. During the LEP of the Vinka primary trainers, the entire fleet was equipped with a g counter. The structural life consumption and severity of the usage is monitored by Patria Aviation by using the tail number-specific g counter e.g. / 50%. Patria also issues recommendations on yearly basis regarding the rotation of the Vinka fleet as well as its fleet leaders. This is to obtain a more even rate of structural life expended and to keep the fleet leaders reasonably ahead of the rest of fleet in flight hours.

Based on the g counter information, the primary trainers are in good structural condition with regard to the flight hours. The severity of usage in view of the g counter status is more benign than that on the basis of LEP assumptions, see *Figure 3*.

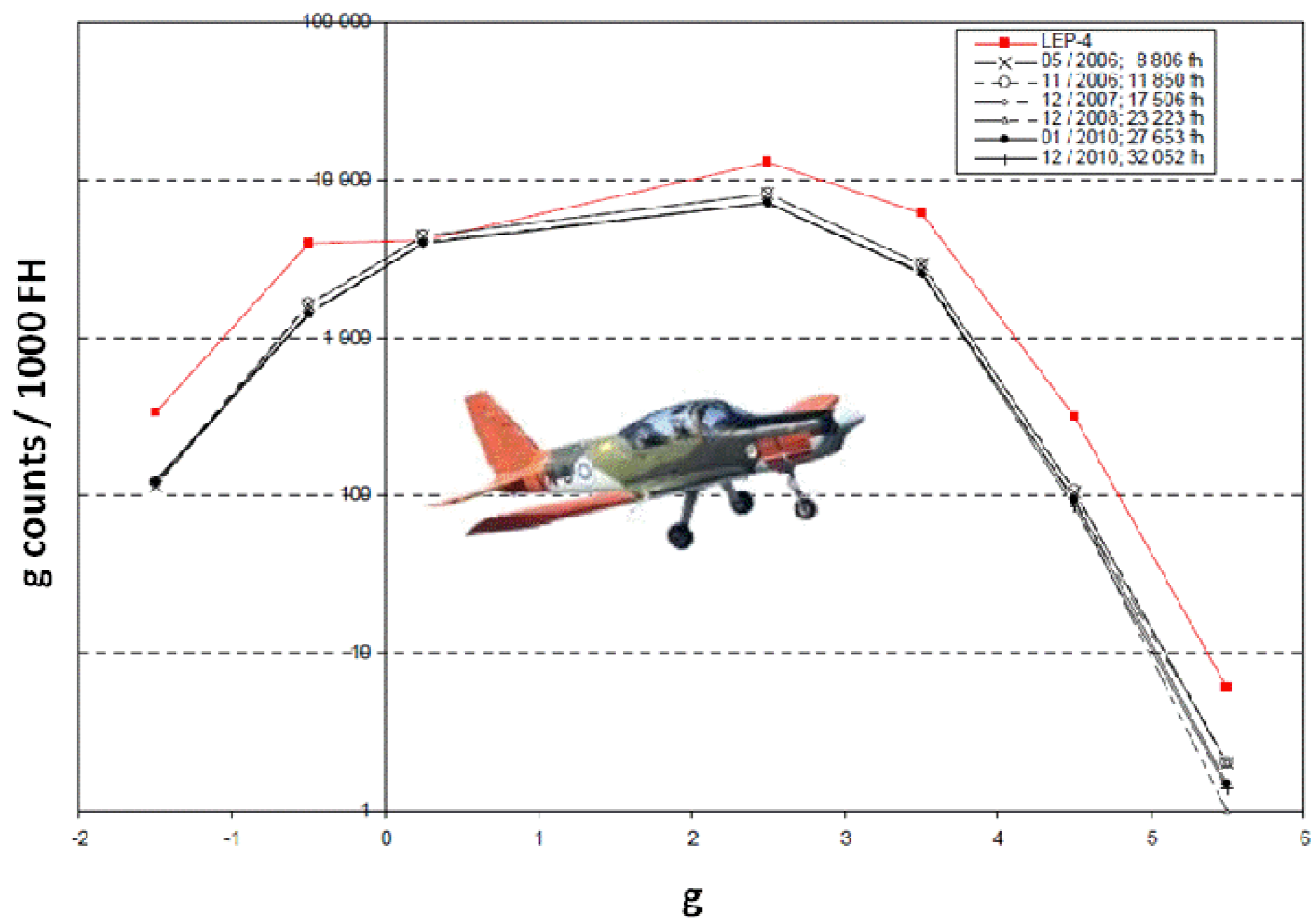

**Figure 3:** The g counts (x-axis) per 1000 FH (y-axis) of the Valmet Vinka. The spectrum representing the LEP design assumptions (LEP-4). The post LEP g counter spectrum as of May 2006 (- x -), as of November 2006 (- o -), as of December 2007 (- ∅ -), as of December 2008 (- Δ -), as of January 2010 (-•-) and as of December 2010 (-|). All curves (excluding the red LEP-4) represent the fleet average from all Vinkas, as ranked according to the a/c center of gravity normal acceleration. Picture by courtesy of Patria Aviation.

### 13.1.2 Hawk Mk51/51A and Mk66

The structural fatigue consumption of the FINAF Mk51/51A Hawks is summarized in *Figure 4*. Further Hawk-related research efforts are provided in *Chapter 13.2.2.5*.

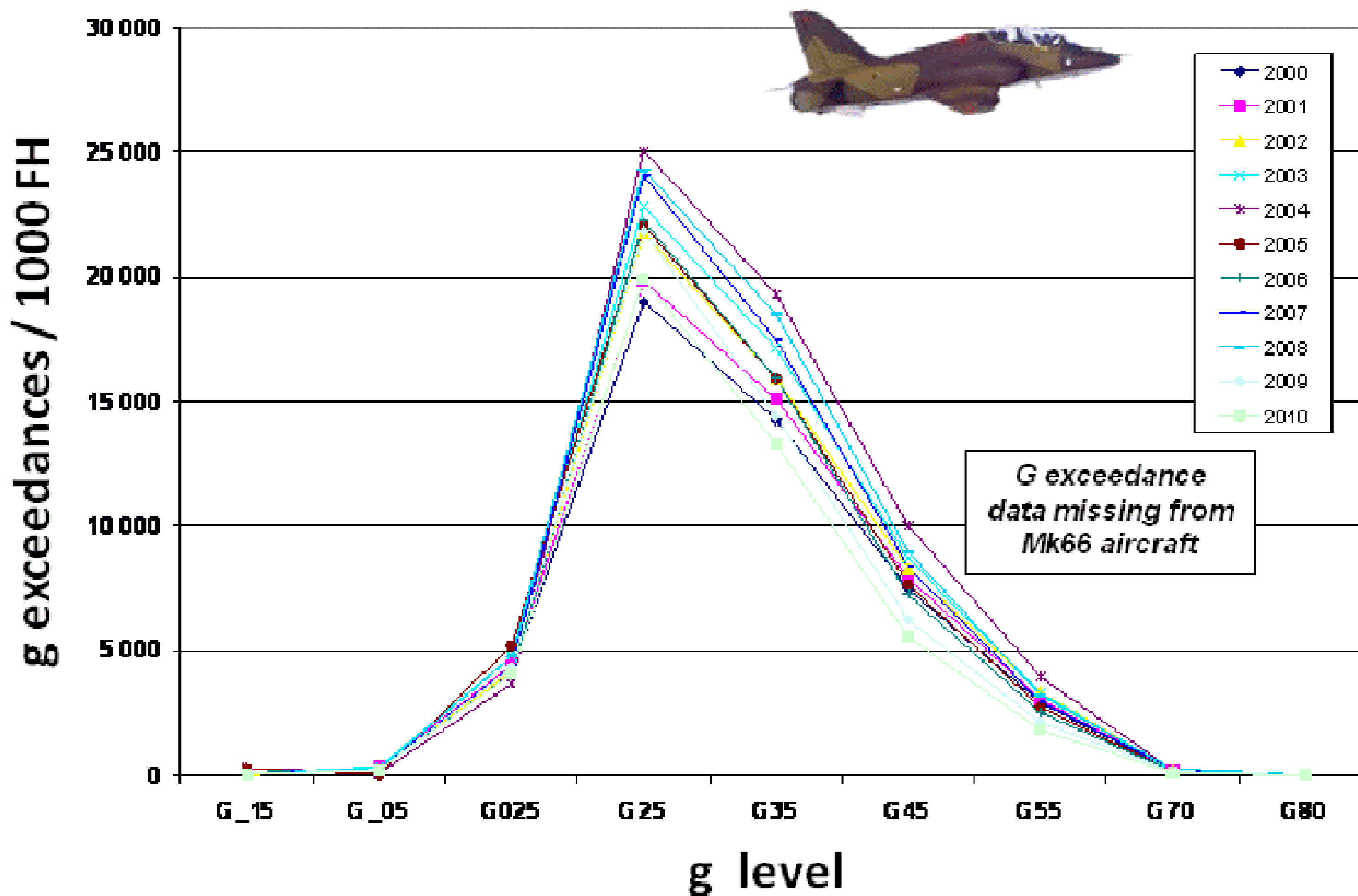

**Figure 4:** *G exceedance development of the FINAF Hawks (Mk51 & Mk51A) at the end of year 2010 (fleet average; data from all 57 aircraft included, as ranked according to the a/c center of gravity normal acceleration. Note that all of the FINAF Hawks have been operating from the Kauhava air base since the end of 2005. Picture by courtesy of the FINAF.*

### 13.1.3 F-18C/D Hornet

Between 2012-2015, Patria will conduct the Mid-Life Upgrade 2 (MLU2) systems upgrade's series installations for the first 35 FINAF Hornet fighters and related manufacturing of components and harnesses. The work will take place in conjunction with scheduled maintenance and structural updates of the aircraft. The goal of the FINAF is to upgrade all of its 62 fighters by the end of 2016. Patria has earlier implemented the first systems upgrade (MLU1) between 2007-2010 and performed the final assembly and testing of 57 single-seat F-18 C models when the fighters were purchased / 53/.

Initially the MLU2 was scheduled to take place after the year of 2015 but it was advanced owing to the information on the life cycle management plans provided by the other operator-countries and the US Navy (USN) under the auspices of e.g. the FISIF (F/A-18 International Structural Integrity Forum). Since most other Hornet operators will retire their fleet before 2023, Finland needed to advance upgrades to its jets to benefit financially from the mass production of the required components.

As a result of MLU2 upgrade, the Finnish F-18s (C and D models) will differ markedly from those of the USN. One significant difference is, for example, the cockpit upgrade with new displays. There are special arrangements to manage the C and D model differences between the USN and the FINAF in the MLU2-induced configurations: The software testing will be done in Finland by the FINAFFTC and Patria's STIC laboratory (Software Test and Integration Centre). For the first



time in the history of the Hornet, there is a foreign (Finnish) organization approved as a part of the approval process of the US software. The MLU2 preparation work is done in co-operation with the Swiss Air Force / 57/.

The current structural life consumption of the FINAF F-18 fleet is shown in *Figure 5*. As presented in the figure, the aircraft usage is more severe than the design target. The FINAF has updated the target as 4500 FH and 0.75 FLE (simultaneously), for the F-18 fleet.

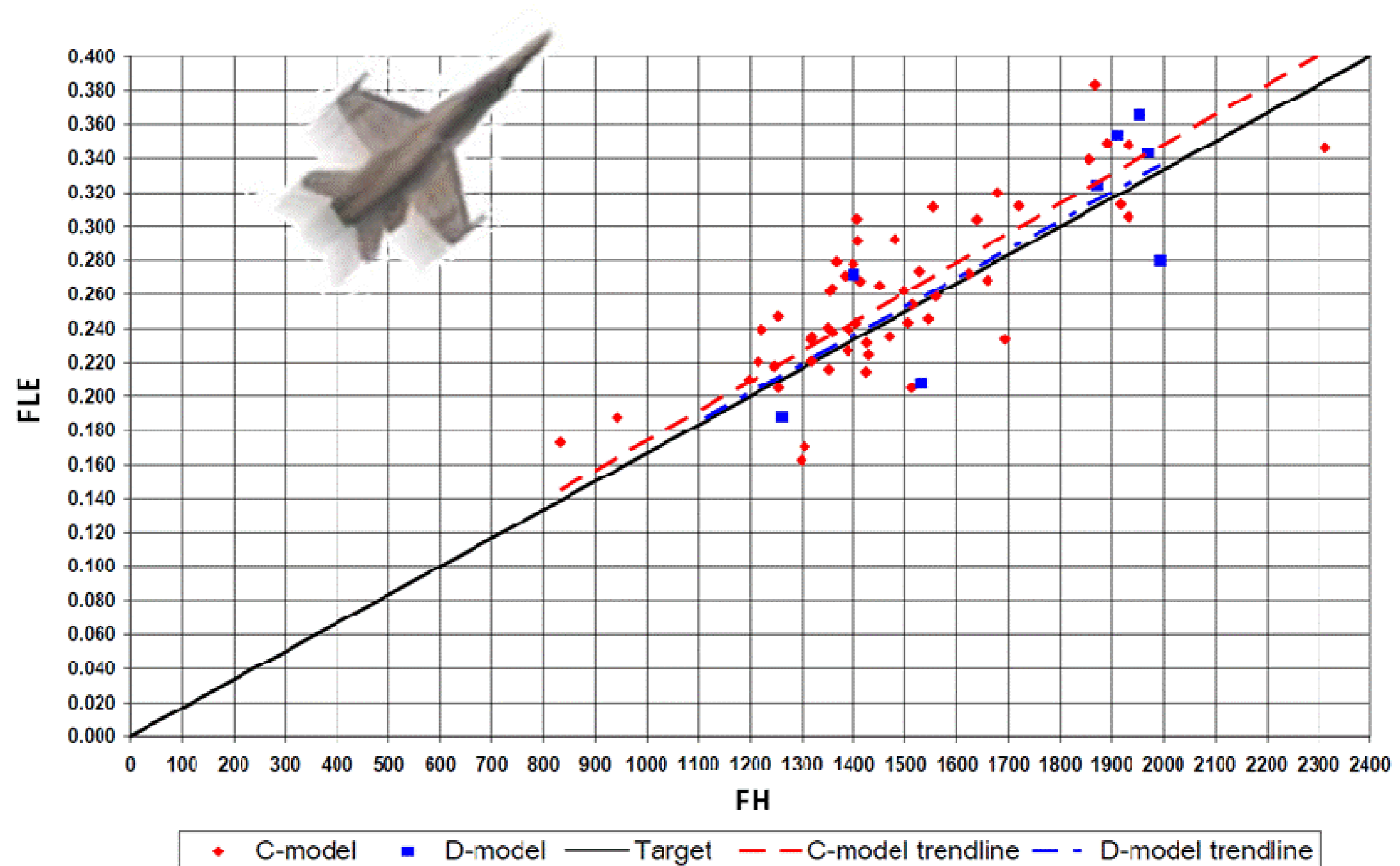

**Figure 5:** Summary of the wing root fatigue life expended (FLE) of the FINAF F-18C/D fleet at the end of year 2010. The data is from all 64 aircraft included. The target is 4500 FH and simultaneously 0.75 FLE. Picture by courtesy of the FINAF.

### 13.1.4 Scope of the review

This national review on aeronautical fatigue concentrates on the fixed wing aircraft inventory of the FINAF related to fighter jets and associated pilot training aircraft. The FINAF inventory today includes 62 F-18C/D Hornet fighters, 48 Mk.51 Hawk jet trainers (+ 18 Mk66 aircraft from Switzerland) and 28 Valmet Vinka primary trainers. During the writing of this review, approximately 108 000 FH have been flown with the Hornets, 229 000 FH with the Mk51 Hawks (+ 18 000 FH Swiss flying with the Mk66s prior to delivery to Finland) and 154 000 FH with the Vinkas.

No FINAF aircraft of these type designations have been lost due to structural issues.

The severity of the Finnish usage in view of structural fatigue with the two jets of noteworthy maneuvering capability can be seen in *Figure 4* (Hawk) and *Figure 5* (Hornet). Figs 4 and 5 clearly demonstrate the need to maintain, further develop and apply concrete and systematic efforts to cope with the structural deterioration effects of these two aircraft types.

During 2005, the International Committee on Aeronautical Fatigue (ICAF) formally welcomed Finland as a full member of the ICAF, making Finland the 13<sup>th</sup> full member. This Finnish national review of current aeronautical fatigue investigations up to March 2011 – although the 6<sup>th</sup> review but the 3<sup>rd</sup> review as a full member – was compiled by Enna Peltoniemi and Aslak Siljander (VTT).

The review comprises inputs from the organizations listed below (in alphabetical order).

Emmecon	Emmecon Ltd, P. O. Box 35, FI-53851 Lappeenranta, Finland ( <a href="http://www.emmecon.fi/">http://www.emmecon.fi/</a> )
FINAFMC	The Finnish Air Force Materiel Command, P. O. Box 210, FI-33101 Tampere, Finland.  The Finnish Air Force Materiel Command, Programmes Division, Aircraft Section, P. O. Box 14, FI-41161 Tikkakoski; Finland. ( <a href="http://www.ilmavoimat.fi/index_en.php">http://www.ilmavoimat.fi/index_en.php</a> )
Finflo	Finflo Ltd, Tekniikantie 12, FI-02150 Espoo, Finland ( <a href="http://www.finflo.fi/">http://www.finflo.fi/</a> )
Millidyne	Millidyne Ltd, Hermiankatu 6A, FI-33720 Tampere ( <a href="http://www.millidyne.fi">www.millidyne.fi</a> )
Patria	Patria Aviation Oy, RTD & Aeronautical Engineering, FI-35600 Halli, Finland ( <a href="http://www.patria.fi/index2.htm">http://www.patria.fi/index2.htm</a> )
Aalto	Aalto University, School of Engineering, Department of Applied Mechanics, Aeronautical Engineering, PO Box 14300, Puumiehenkuja 5 A, FI-00076 Aalto, Finland ( <a href="http://appmech.tkk.fi/en/research/research_group1/">http://appmech.tkk.fi/en/research/research_group1/</a> )
TUT/DSP	Tampere University of Technology, Department of Signal Processing, Korkeakoulunkatu 1, FI-33720 Tampere, Finland ( <a href="http://sp.cs.tut.fi">http://sp.cs.tut.fi</a> )
TUT/DMS	Tampere University of Technology, Department of Materials Science, Korkeakoulunkatu 6, FI-33720 Tampere, Finland ( <a href="http://www.tut.fi">http://www.tut.fi</a> )
TUT/IHA	Tampere University of Technology, Department of Intelligent Hydraulics and Automation, P.O. Box 589, FI-33101 Tampere, Finland ( <a href="http://www.iha.tut.fi/research/aircraft/">http://www.iha.tut.fi/research/aircraft/</a> )
VTT	VTT Machine and Vehicle Industries, P. O. Box 1000, FI-02044 VTT, Finland ( <a href="http://www.vtt.fi/?lang=en">http://www.vtt.fi/?lang=en</a> )

## 13.2 Current activities: ASIMP 2007-2009 and ASIMP 2010-2012

The Aircraft Structural Integrity Management Program (ASIMP) 2007-2009, as briefly outlined in / 20/, has been completed. The follow-on program, the ASIMP 2010-2012 with its various sub-programs, has been started and it is well underway. An attempt is provided below to provide highlights of the ASIMP 2007-2009 and ASIMP 2010-2012 achievements thus far, including those from the parallel research programs.

### 13.2.1 Loads and stresses

#### 13.2.1.1 Computational fluid dynamics (CFD) – update

Previous CFD activities (flow simulations) have been reported in e.g. ICAF 2009 Chapter 13.2.1.1. Computational fluid dynamics (CFD) research at Finflo Ltd is based on the in-house flow solver FINFLO. Recently the FINFLO code has been developed for external store separation that was also described in ICAF 2009 Chapter 13.2.1.1. The 6-DOF model utilizes a Chimera technique. The same kind of approach has been extended for calculating helicopter rotor blades. The main goal of the rotor simulations is to get more information and knowledge about the aerodynamics of the helicopter rotor. Another purpose is to use the simulation tool in the maintenance work of NH90 fleet.

The rotor of the Blackhawk UH60 has been used for validation purposes, because there is a lot of public information for the UH60. The rotor model solves only two of the Euler angles of the complete 6-DOF model. In both models a fourth-order Runge-Kutta integration is applied for a solution. The calculations are made for each rotor blade separately, but in some cases the blades may interact with each other's via the hinge coupling mechanism. The aerodynamics of the blades is affected by the wake and the tip vortices of the other blades.

The resulting flow structure is very complicated. In *Figure 6* a vortex wake structure behind the UH60 rotor in forward flight is shown. A vorticity value is visualized by an iso-surface and a helicity is drawn in color. In the time-accurate simulation approximately 30 flow iterations were done at every time step. A time-step size was 0.0005 seconds corresponding to a 0.76 degrees rotor angle. Lagging and flapping are moving freely and they are solved by the 2-DOF equations. A pitch angle is defined by using cyclic movements and a specified additional angle. The specified additional angle is used for deformation modeling. In this simulation the rotor blades are rigid and deformation has been added to the simulation by the additional angle.

The deformation of the helicopter blade has been taken into account also in another case example. This is accomplished by coupling the flow solver (FINFLO) and the Nastran code. The simulation is still very time-consuming, but the elasticity of the blade has a significant effect on the aerodynamics and it should be taken into account.

Chimera method is applied in simulating flow fields around F-18C fighter. The basic features of the method are described in / 60/ and / 61/. The Chimera method utilizes accurate wall distances. The computation of those is time-consuming, but the method has been enhanced significantly during the recent years. A restriction of the Chimera method is often in different grid densities in the Chimera and the background grids. In 2010 a new grid for the F-18C was developed and considerable improvement has been obtained in the accuracy of the Chimera interpolation in the narrow gaps between the flaps and the wing.

Co-operation with CFSE and RUAG has been continued. Meetings have been arranged to handle technical aspects and general CFD development. CFD solutions between the FINFLO and Navier-Stokes Multi-Block (NSMB) codes applying different turbulence models have been compared with a satisfactory agreement.

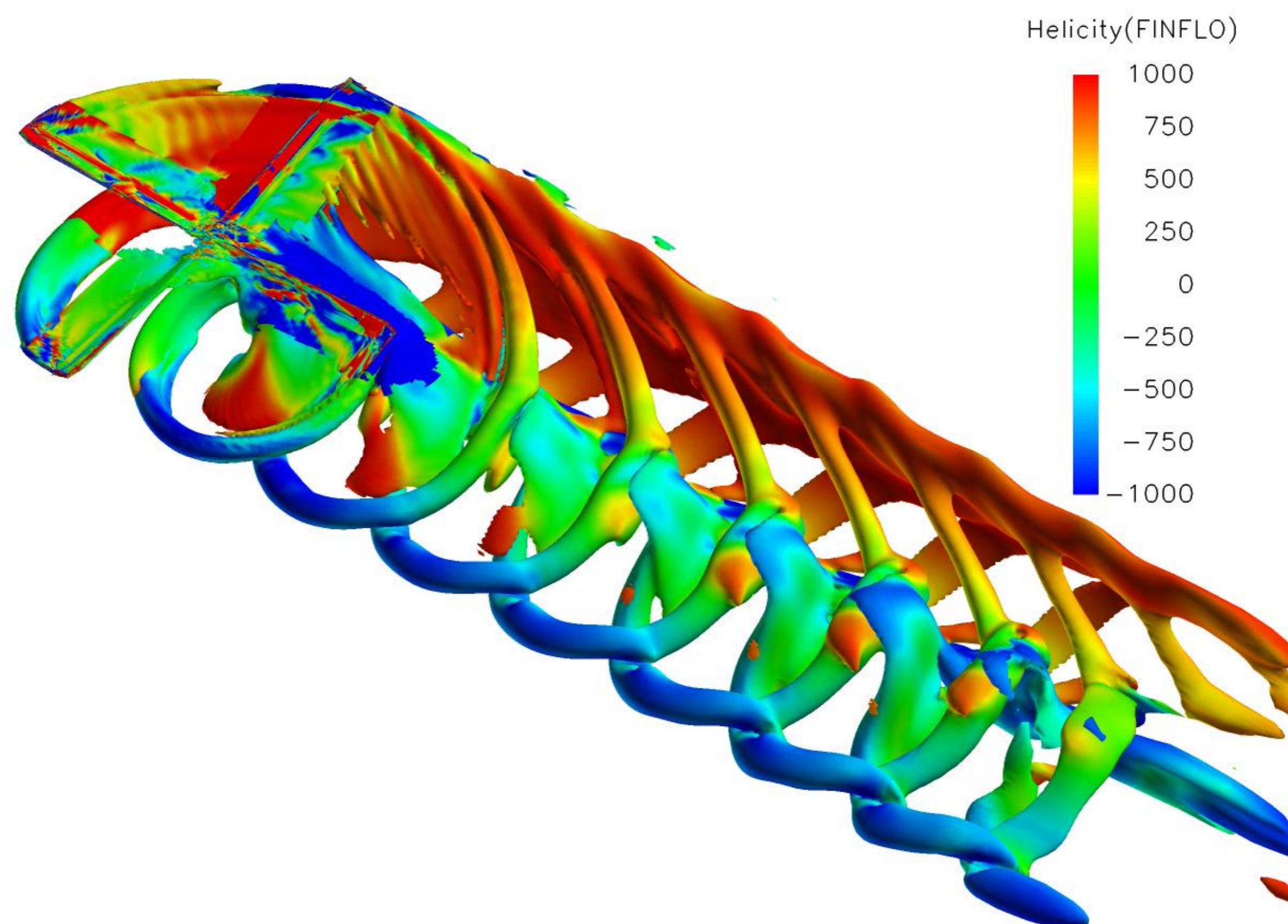

**Figure 6:** A vortex wake structure behind the UH60 rotor in forward flight. The vorticity iso-surfaces are colored by the helicity value. Picture by courtesy of Finflo Ltd.

### 13.2.1.2 Flight simulations

Previous activities of the flight simulations to support the structural fatigue life management have been highlighted in e.g. ICAF 2009 Chapter 13.2.1.2. The FINAF has continued the funding of the development of the low-cost flight simulation software. The software has been (and will be) utilized among the national research network in various projects (see also **Chapter 13.2.2.2**). Modular design allows different aircraft models to be implemented into simulations. Among the most important ones are the F-18C and Hawk aircraft models.

The associated elements (software/hardware) have been upgraded when needed in order to maintain the simulation capability in a level corresponding to the actual flying of the FINAF aircraft. The following provides an update of the activities:

- A manual for the Flight Analyzer and visualization tool for the multiple aircraft parameter dependency analyses for a given structural location was written, mainly for the internal use at VTT and as a reference for analyses (also mentioned in **Chapter 13.2.2.5**). / 23/
- The comparison of two cases of external store separation from F-18C is presented in report / 64/. The external store flight path data after it was released from the ejector was provided by Finflo Ltd (both location and position information). The data was compared with the store flight path calculated at VTT with a Matlab tool designed solely for this purpose. The translations, angles of attack and angular velocities had the best fit when compared with each other during the first 0.5 seconds.
- A brief study of how to implement external stores into the modular design of the F-18C flight simulation model HUTFLY2 was done / 54/. (For HUTFLY2, see ICAF 2009 for more information.)
- A tool for postprocessing HUTFLY2 flight simulation results was developed. The postprocessor enables the user to draw figures and to animate flights from several types of output files. The tool is developed to do the postprocessing in Matlab language, but use as a standalone application is also possible. / 79/
- Trim routine was developed to properly initialize the aircraft for simulation in selected flight conditions. More details of the trim routine activities are provided below in **Chapter 13.2.1.2.3** (“trim routine development”).

- The work is proceeding towards the goal i.e. to create flight visualization routines such that the most damaging flights could be visualized / 20, Chapter 13.2.2.6.2/. The results, in addition to the ones mentioned above, are highlighted elsewhere in this document (*Chapters 13.2.2.2 and 13.2.2.5*).

#### 13.2.1.2.1 Trendlines in the fatigue tracking of Hornet flights and damaging maneuvers

Previously 800+ HOLM (Hornet Operational Loads Measurement program, see *Chapter 13.2.2.1*) flights had been analyzed and reported and now they were compared with the newest set of HOLM flights. Selected critical structure locations were studied and also compared with flight maneuvers that were flown during the same period. The most damaging flight maneuvers were searched with the aid of Flight Analyzer. These maneuvers were also visualized. / 24/

#### 13.2.1.2.2 The analysis of the two Hornet flights in view of wing stressing

Two comparative flights were flown with the one of the FINAF F-18's with the onboard HOLM instrumentation suite. The aim was to determine the effect of the wing tip missile on wing structure fatigue. The flight maneuvers were predetermined and those were studied individually in both cases (flights). Analyses were also made to filtered signals, i.e. buffet-induced dynamic loadings were excluded. / 65/

#### 13.2.1.2.3 Trim routine development

Setting an aircraft model in equilibrium (i.e. trimming) is essential in advance of actual flight simulation. Trimming is accomplished by the specific procedure (trim routine) which initializes the simulation at given flight conditions by defining steady-state rates and accelerations and by initializing flight control system, control surface deflections and throttle settings. The results from the trim routine form the basis for the following flight simulations and/or CFD-calculations.

At VTT, the trim routine has been under development in the Matlab/Simulink environment for the simplified F-18C Hornet aircraft model of the HUTFLY2 flight simulation software. The first steps in developing a trim routine for the flight simulation environment were – due to analogous methodologies – based on the inverse simulation capability that was developed in previous projects / 70/ / 78/. However, some features of the prototype version were somewhat limited and the update of the procedure became later a topical issue.

The updated trim routine / 71/ is, as its predecessor, a numerical method which is in turn based on the minimization of a quadratic cost function derived from the translational and rotational accelerations. The minimization algorithm utilizes the built-in Matlab function which returns the values of control inputs that make the cost function zero within a given tolerance. The promising results from the updated trim routine have been verified against the reference values in a variety of flight conditions (including level flights, pull-ups, push-overs, turns and rolls).

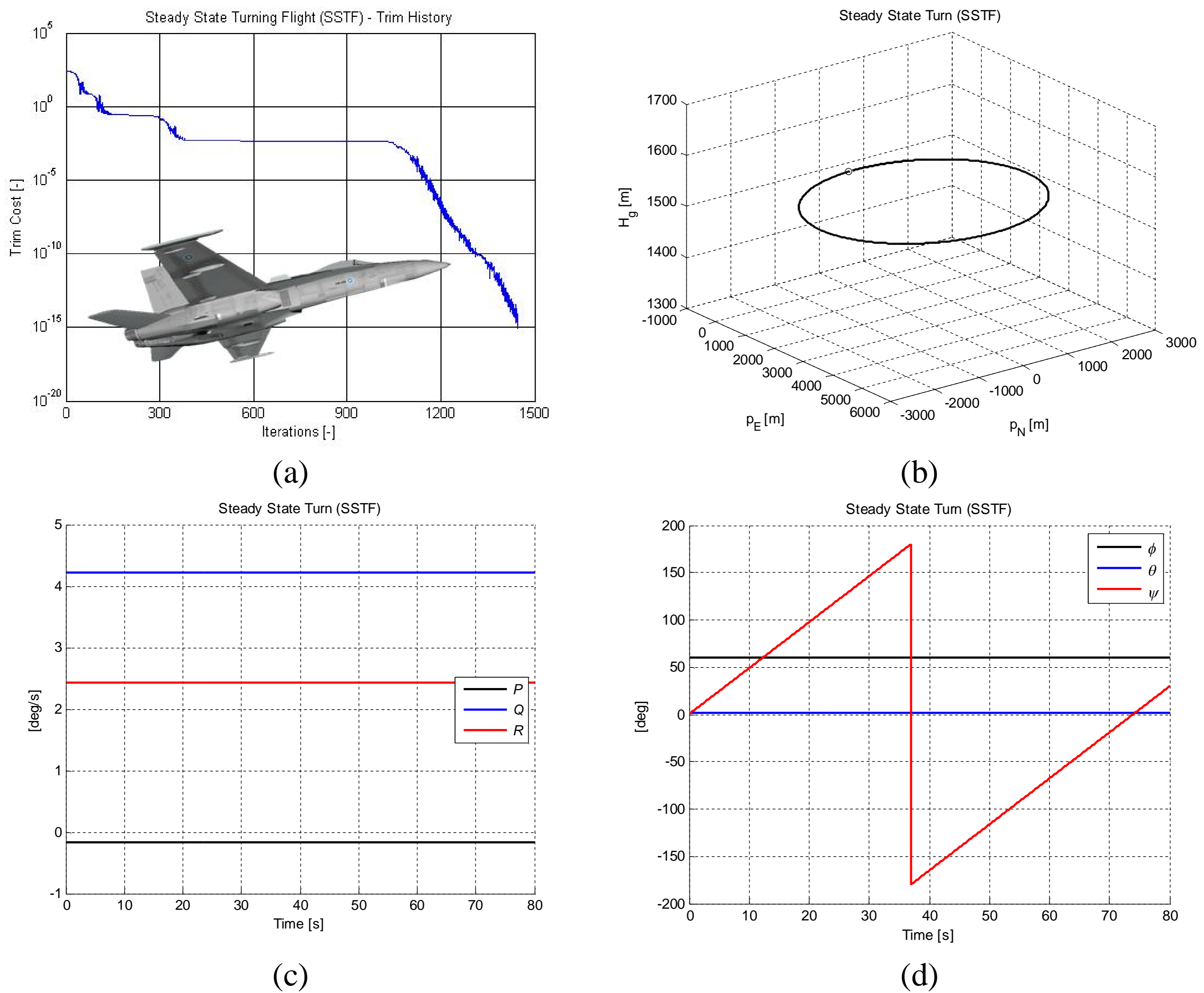
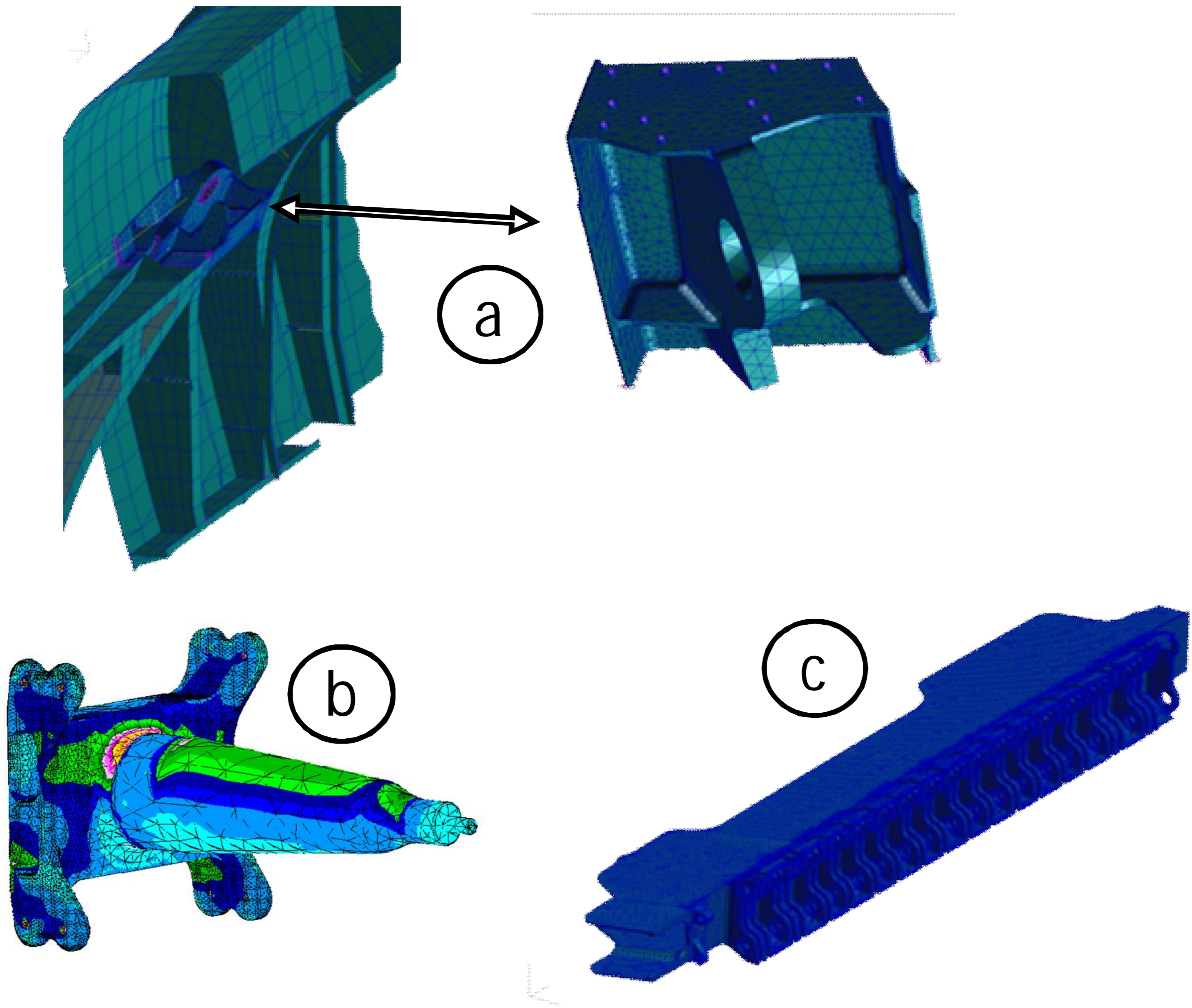

**Figure 7:** Results from the updated trim routine while trimming the given aircraft in  $60^\circ$  steady-state turn: a) history of the cost function, b) track of the 80 sec simulation with the solved trim parameters, c) body frame angular rates and d) the Euler angles ( $-\pi \leq \phi < \pi$ ,  $-\pi/2 \leq \theta < \pi/2$ ,  $-\pi \leq \psi < \pi$ ). Picture by courtesy of VTT.

### 13.2.1.3 Hornet FE modeling – update

Previous development phases of the global and detailed finite element (FE) modeling of the FINAF F-18C Hornet have been outlined in ICAF 2007 Chapter 13.5.1.1 and in ICAF 2009 Chapter 13.2.1.3. Since then some new detailed FE models have been prepared: horizontal tail bootstrap / 51/, spindle / 42/, and inner wing fold rib / 43/, **Figure 8**.

The fatigue life estimates for HT spindle box and bootstrap have been determined with applicable strain gauge data of 10 Mini-HOLM 1 test flights representing FINAF average usage / 19, Chapter 13.5.1.3.1/. These locations have also been included under continuous monitoring in the HOLM (two special instrumented a/c, see **Chapter 13.2.2.1**) and the parameter based (whole fleet, see **Chapter 13.2.2.3**) fatigue tracking systems.



**Figure 8:** Detailed FE models: a) horizontal tail bootstrap, b) spindle and c) inner wing fold rib. Picture by courtesy of Patria Aviation.

## 13.2.2 Fatigue tracking systems

### 13.2.2.1 FINAF F-18 HOLM jets in routine squadron service

Previous research activities of the two FINAF F-18 HOLM (Hornet Operational Loads Measurement program) jets can be found in ICAF 2009 Chapter 13.2.2.1. Like the other Hornets, the two HOLM jets, the tail numbers HN-432 and HN-416, are rotated in the Satakunta, Lapland and Karelian Air Commands.

The “production” version of the HOLM onboard system has collected statistically reliable flight data from routine fleet usage of the FINAF since 2006. The database consists of over 1100 analyzed “production” flights. The flights are analyzed continuously at VTT as the flight data is delivered from the FINAF squadrons to VTT:

- Up to 844 flights were analyzed and reported in / 66/.
- The onboard HOLM instrumentation is periodically calibrated by VTT. The annual electrical calibration of HN-416 and HN-432 reveals if any changes have occurred or the calibration coefficients need to be adjusted. Based on the calibration results from the recent years e.g. / 68/ / 69/, the quality of the system is outstanding: the quality of the strain signals is good (no spikes found) and all the recordable strain data has been captured (minimal missing data). This all forms a good base for all the analyses that are made based on the HOLM data.
- The HOLM fatigue analysis database has been updated / 67/. The database works seamlessly with the data from the OLM/HOLM ground analysis environment. In addition to data from the fatigue tracking system the database includes all the needed information from the data analysis process.
- Preliminary values for cut-off frequencies in Butterworth low-pass filtering were determined for each strain gage signal / 56/. The goal is to filter out the buffet-induced dynamic effects such that only the maneuver-induced effects remain. The cut-off frequencies are to be used in analyzing the structural damage in the Flight Analyzer:  $\text{Damage}_{\text{BUFFET}} = \text{Damage}_{\text{TOTAL}} - \text{Damage}_{\text{MANEUVERING}}$ .
- The OLM/HOLM ground analysis environment has been further developed and new analysis capabilities have been implemented / 3/. Testing and verifying the modular structure of the analysis software is also included in the report. The same analysis environment is used for both FINAF Hawks (OLM) and Hornets (HOLM) and the current analysis environment is continuously developed to further improve the life prediction accuracy.
- Using the bulk of collected and analyzed HOLM data (in *Chapter 13.2.2.2*), VTT’s FMI efforts are focused on finding the most damaging maneuvers for a given structural detail on the basis of the most damaging sorties and flights identified. Having identified the most damaging flight for a given structural detail, the time segment producing the highest calculated damage is located. Using the Flight Analyzer -tool developed at VTT, the maneuver producing the highest calculated damage is visualized. An extensive identification of the most damaging flight maneuvers from the bulk of HOLM data was done during 2009 / 21/. The results were interpreted to selected F-18 structural details. It revealed also some observations about the use of flight controls usage (personal flying style).

### 13.2.2.2 Flight maneuver identification (FMI) – update

The usage of the FINAF F-18 fleet is more severe than the design target inducing needs to reduce the fatigue damage rate for several structural areas. The preferred way for damage rate reduction would be elimination of unnecessary damaging features from the current usage but also more profound actions about the usage may be needed. Hence, Patria Aviation, TUT/DSP and VTT, under FINAF funding, started / 20, Chapter 13.2.2.2/ the development of means and tools for finding the most damaging flight event or maneuver types for the critical structural locations, and, analyzing the causalities between the rate of damage and different parameters/elements of the



flight events – aiming to support in decisions on the actions for reducing the structural life consumption.

The HOLM system / 20, Chapter 13.2.2.1/ / 19, Chapter 13.5.1.3/ installed on two FINAF F-18 Hornets enables estimation of fatigue life expenditure (FLE) accumulation for each fatigue-critical structural detail even for in-flight events and/or maneuvers having duration of seconds. Combined with the concurrently recorded HOLM flight parameter data the relations between the usage of the aircraft and the produced FLE can be studied. An overview of the study by the FINAF, Patria, TUT/DSP and VTT is highlighted in **Figure 9**. VTT verifies and analyses the HOLM data, and peruses the data to identify and visualize the most damaging flights and the maneuvers therein. Patria contributes especially to the structure-related analyses of the flight parameter recordings. TUT/DSP develops signal processing and data mining methods which aid in utilizing the extensive flight recordings database in automatic manner. With joined efforts, the parties can rise to the challenge of this multidisciplinary research.

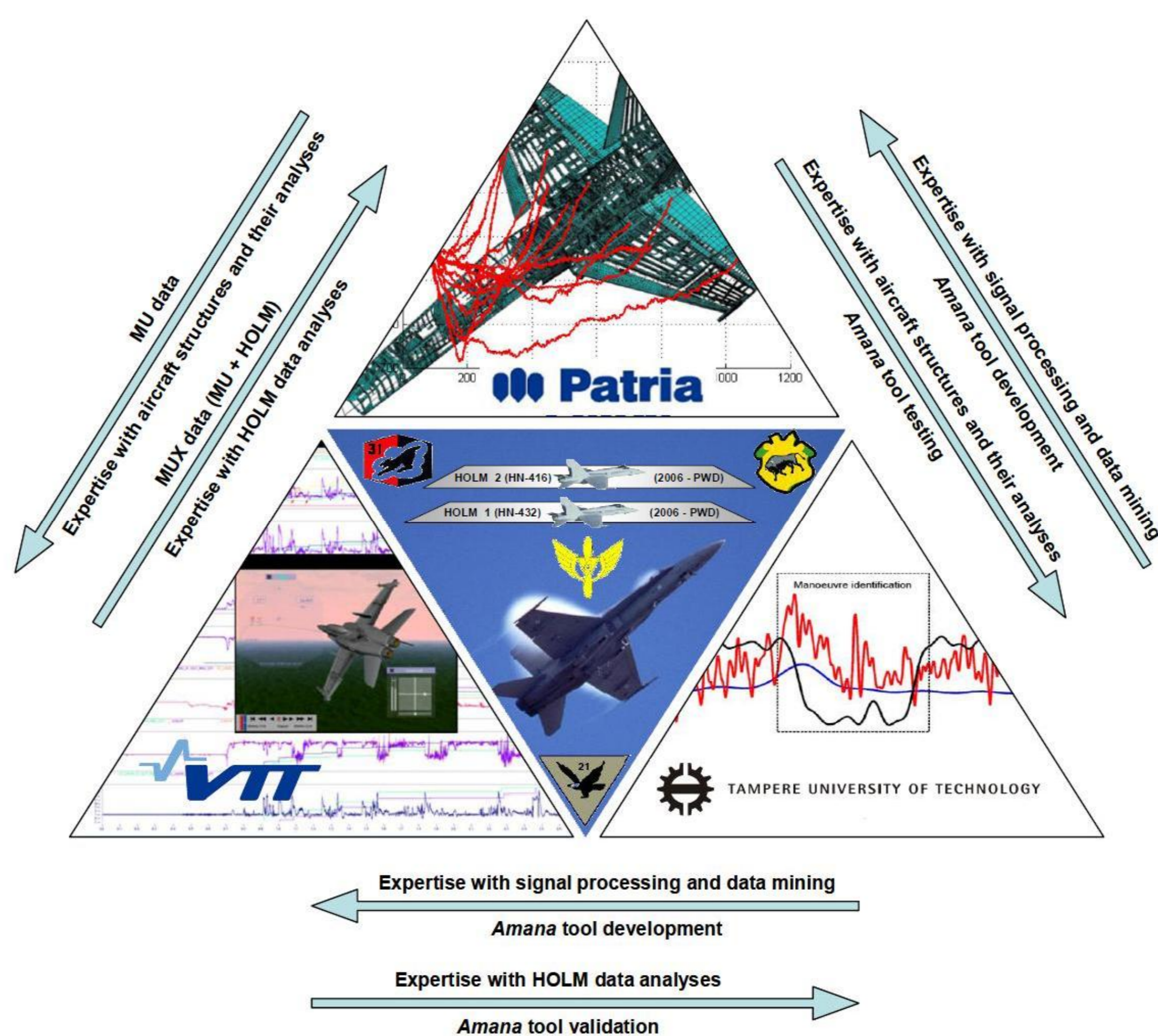

**Figure 9:** An overview of joint research efforts related to flight maneuver analysis between the FINAF, Patria Aviation, TUT/DSP and VTT. AMANA software is a tool for flight maneuver detection, developed by TUT/DSP. Picture by courtesy of VTT / Patria / TUT/DSP.

#### 13.2.2.2.1 Flight data driven aircraft usage analysis

Earlier approach to studying the most damaging flight maneuvers is provided in / 30/ / 58/. In that paper, a software tool called AMANA for flight maneuver detection from flight parameter data was introduced. Since then the AMANA tool has been enhanced. As a latest advancement, data models for several flight maneuvers have been created and a model library has been constructed, referred to as a template library. The library instructs the software about what the interesting events look like in the data. **Figure 10** illustrates the data mining environment as a block diagram. Template related work, which consists of choosing and modeling flight maneuvers, requires knowledge about the usage, behavior, and structures of the aircraft. Comprehensive fatigue analysis calls for systematic modeling of all the most damaging flight maneuvers for each fatigue-critical structural detail. When the template library has been created, the AMANA software utilizes the template library and finds all the matching maneuvers from the flight parameter data recordings in automatic manner.

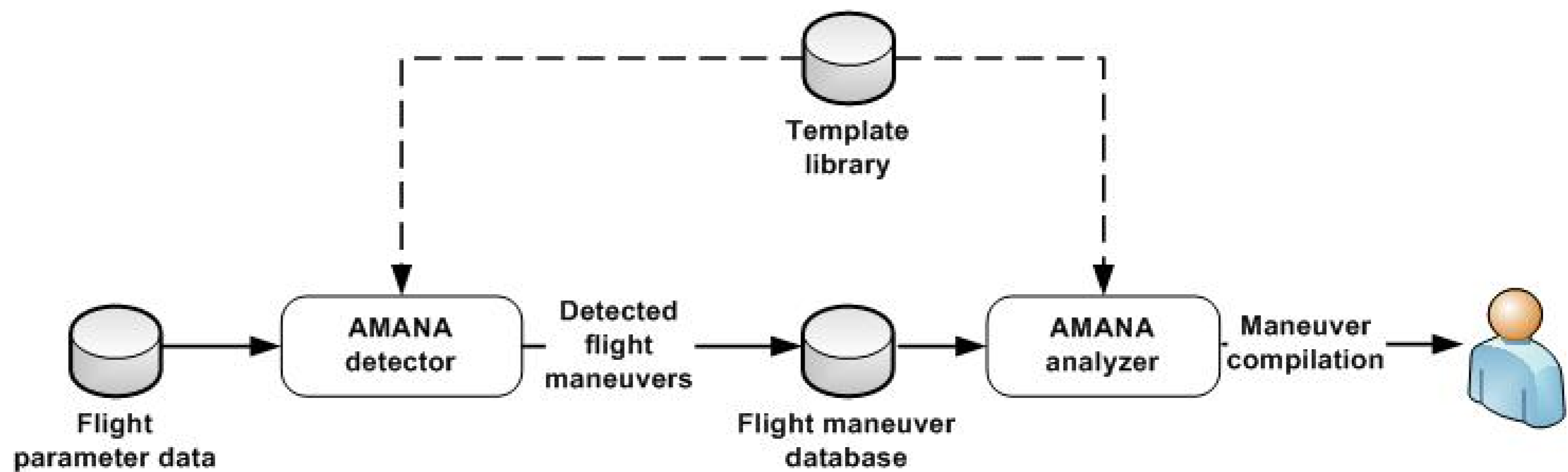

**Figure 10:** The block diagram of the procedure for flight maneuver analysis. The creation of the template library requires manual work of an analyst, but actual flight maneuver identification using the AMANA tool is fully automatic. The template library enables comprehensive analyses /31/. Picture by courtesy of TUT/DSP.

#### 13.2.2.2.2 Flight-maneuver-specific fatigue estimation

The discussed FLE analysis involves a fundamental question about how to estimate fatigue life expended during a *short* event in flight. In this study, two different methods are applied. The Strain Life method with the Rainflow cycle counting forms the basis for the methods.

In the first method, the fatigue damage is calculated for closed strain loops (cycles) over a flight. The cycles' peaks and valleys represent load reversals in the signal and they may be related to phenomena within a single maneuver (e.g. heavy vibration of structure during high-angle-of-attack pull-up) or to totally different and separate maneuvers. Here the damage of the cycle is shared evenly to the peak and to the valley because they both have contribution on the damage. The total damage of a maneuver is produced by summing up all the peak and valley damages during the maneuver.

The second method excludes completely the effects of events before and after the maneuver on the fatigue damage. The fatigue damage is determined by feeding the load history within the maneuver into strain life analysis. It must be noticed that even if the whole flight would be covered with defined maneuvers the sum of the maneuver-wise calculated damages is usually not equal—or even close—to the damage calculated for the whole flight.

Both of these methods are exploited depending on if the aim is to analyze the aggregate contribution of a bunch of events (first method) or the contribution of a single maneuver event (second method).

#### 13.2.2.2.3 Flight maneuver FLE compilation

Flight maneuver FLE compilation is calculated to get a general understanding of severity of the different maneuvers. **Table 1** gives the relative FLE of seven (7) considered maneuver types over four (4) structural details, i.e. each maneuver type's share of the total FLE over the flight set for each structural detail. The results show, for example, that split-S, turn, and loop are the most severe maneuvers for vertical tail root, and they cover almost half of the total damage. Based on the compilation, the significantly damaging maneuvers for each structural detail can be chosen for further analysis.

**Table 1:** A compilation of the found maneuvers and their share of the total fatigue damage accumulation in 297 HOLM flights / 31/. Picture by courtesy of VTT / Patria / TUT/DSP.

Structural detail	Vertical tail root			Inner wing shear tie			Fuselage bulkhead			Elevator spindle		
	Proportion of detected maneuvers in flight set total damage			Proportion of detected maneuvers in flight set total damage			Proportion of detected maneuvers in flight set total damage			Proportion of detected maneuvers in flight set total damage		
	Damage allocated to peaks	Damage allocated to valleys	In total	Damage allocated to peaks	Damage allocated to valleys	In total	Damage allocated to peaks	Damage allocated to valleys	In total	Damage allocated to peaks	Damage allocated to valleys	In total
Split S	28 %	29 %	28 %	2 %	2 %	2 %	0 %	1 %	0 %	0 %	0 %	0 %
Turn→roll→turn	0 %	1 %	1 %	8 %	5 %	7 %	0 %	1 %	1 %	9 %	10 %	9 %
Turn	12 %	12 %	12 %	30 %	17 %	24 %	58 %	0 %	29 %	17 %	13 %	15 %
Loop	7 %	6 %	6 %	2 %	1 %	1 %	3 %	1 %	2 %	0 %	2 %	1 %
Push	0 %	0 %	0 %	0 %	0 %	0 %	0 %	3 %	1 %	0 %	0 %	0 %
Roll	3 %	1 %	2 %	3 %	5 %	4 %	0 %	0 %	0 %	66 %	46 %	56 %
Oblique loop	2 %	2 %	2 %	1 %	1 %	1 %	2 %	0 %	1 %	0 %	0 %	0 %
Sum	51 %	50 %	51 %	45 %	30 %	37 %	63 %	6 %	34 %	91 %	72 %	81 %

The developed methods and the software together with the template library allow us to perform maneuver-specific fatigue assessment and achieve knowledge concerning the fatigue-criticality of various flight maneuver types. This lays a foundation for detailed analysis of the identified, nominally similar, maneuvers and identification of the crucial features/actions within the maneuvers that are causing the worst fatigue. In the near future, we are striving to develop a method for mining knowledge about the causes of FLE inside the maneuvers. By using the new method, we are able to process all the thousands of the found maneuvers in the maneuver database and produce sophisticated information about causes of diverse FLE produced by nominally similar maneuvers.

The discussed analysis framework supports the fatigue life management and may provide valuable guidance for adjustments to the content of the flight training syllabi when the aim is to reach the target lifetime or increase the lifetime of the fleet and reduce operating costs. More details of the study are provided in ICAF 2011 oral presentation “Link between flight maneuvers and fatigue” / 31/.

### 13.2.2.3 Parameter based fatigue life analysis - update

Parameter based fatigue life analysis is individual aircraft fatigue life monitoring system developed for the FINAF F-18 Hornet fleet. It utilizes flight parameter data, stored by standard aircraft systems, and artificial neural networks (ANN) to produce flight-specific fatigue damage. The fatigue damage (SAFE-life) estimates are calculated for 12 structural locations. Previous development phases of the system have been presented in / 20, Chapters 13.2.2.3-13.2.2.5/ / 19, Chapter 13.6.3/ / 18, Chapter 5.3/.

The Parameter based fatigue life analysis is now a qualified system and its results are part of the decision making process in the fatigue life management of the FINAF F-18 fleet. The findings help to get a general view of Fatigue Life Expenditure (FLE) in the fuselage, wing and tail areas and also provide FLEs of the structural details. Repairs, inspections and structural part replacements can be scheduled based on the results. The FLE results for some critical locations are still unreliable by absolute values due to problems in the transfer function values produced by FEM, but as performance of the ANNs for all locations have been verified to be of good quality, the FLE results for all locations are usable for relative comparisons between individual aircrafts or for examining FLE trends in function of time.

About half of the flights flown by the FINAF have been analyzed by now and annual report delivered to the FINAF. The rest of the flights are in the process. For example, in **Figure 11** is FLE distribution of FINAF F-18 fleet. The FLE is calculated for a fuselage bulkhead. **Figure 12** shows FLE accumulation rate of a fuselage longeron over period of 4 months and 12 months. It indicates how the usage of the aircrafts has been changed over the period 2000-2007.

During the last two last years the analysis has been extended to cover up to 3 features in one structural location (e.g. 3 fastener holes in the same structure). The first in-service performance assessment will be carried out this year. Additional information of the system is available in / 63/ / 32/.

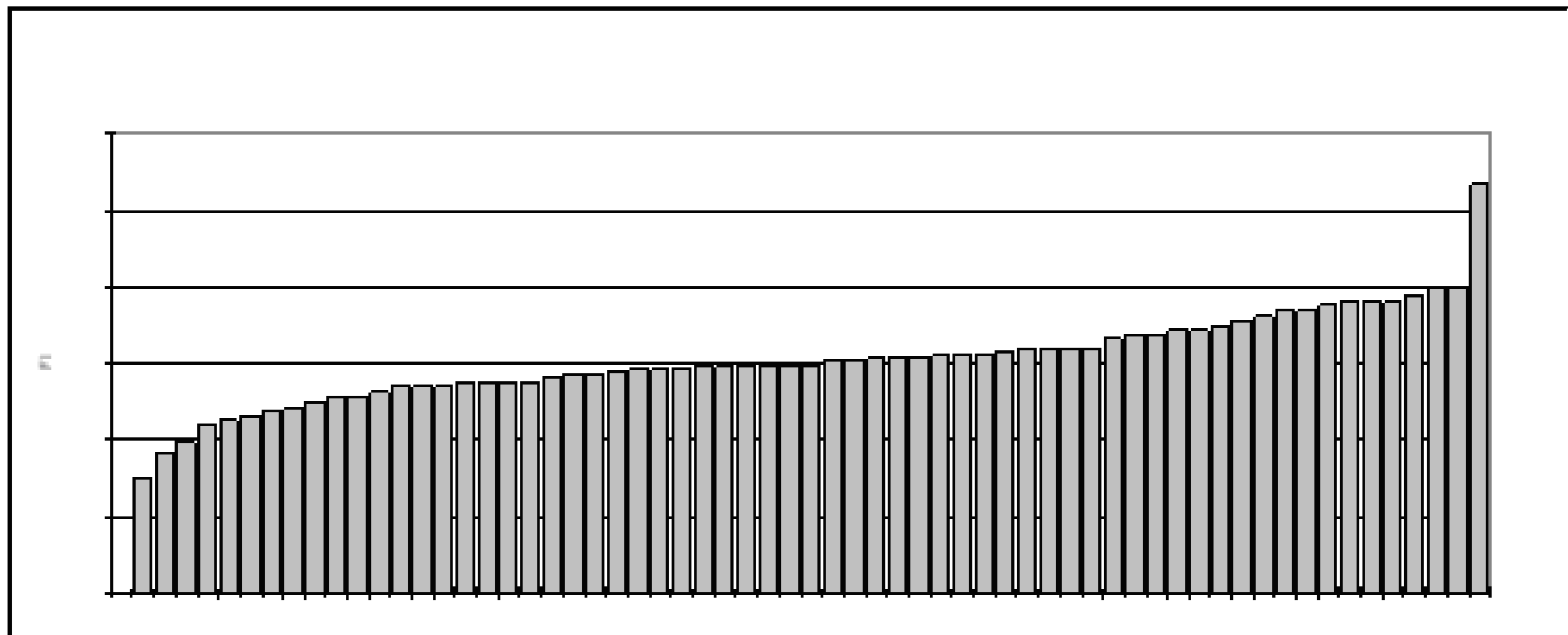

**Figure 11:** Example of FLE distribution of FINAF F-18 fleet for fuselage bulkhead. Each bar denotes the FLE of an individual F-18. The fleet leader stands out from the fleet. Picture by courtesy of Patria Aviation.

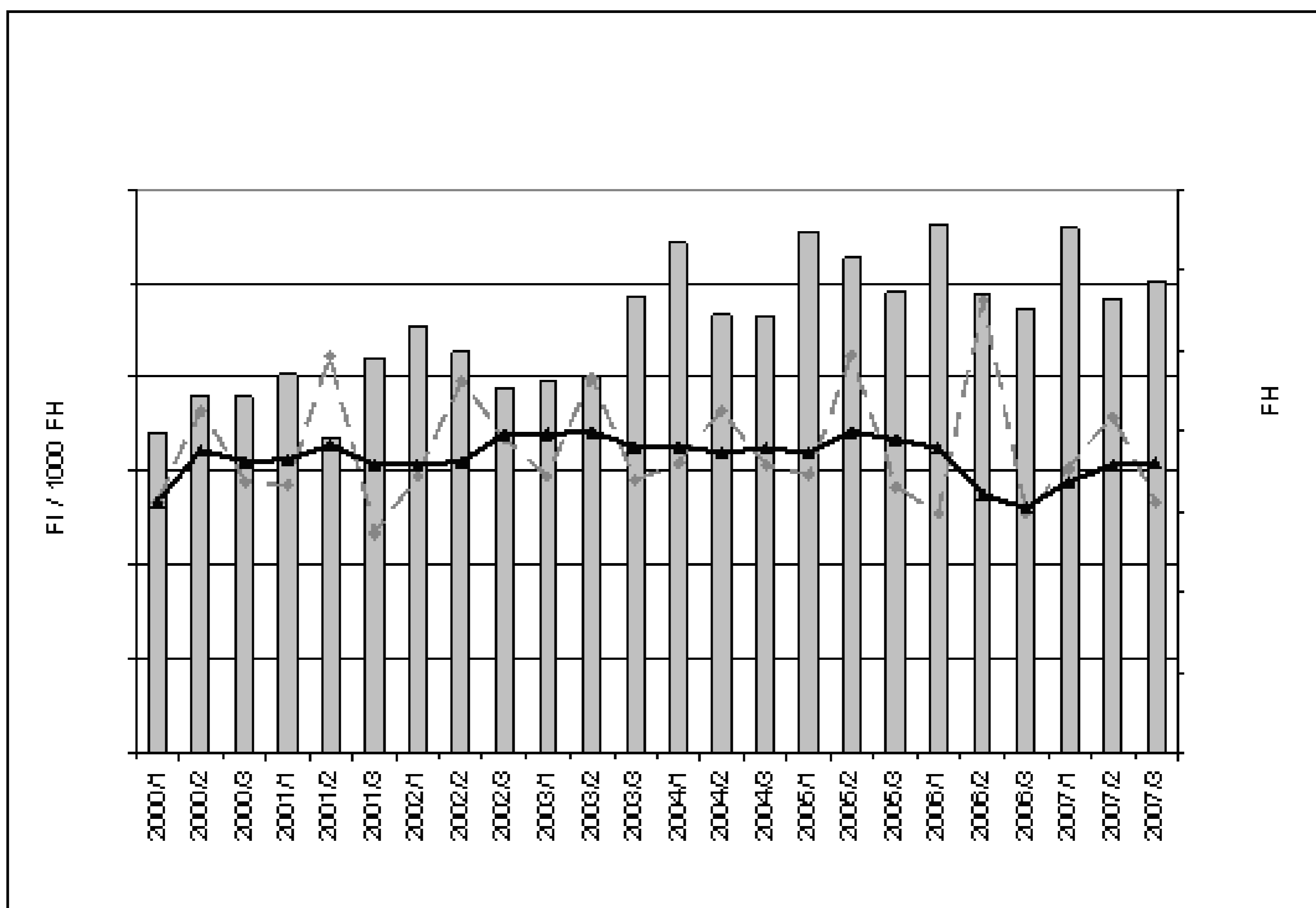

**Figure 12:** FLE accumulation rate of a fuselage longeron over period of 4 months and 12 months. The bars denote flight hours, the black line denotes 12 months accumulation rate and grey line denotes 4 months accumulation rate. Picture by courtesy of Patria Aviation.

#### 13.2.2.4 Adding non-instrumented structural locations into fatigue tracking

The activities to increase the number of the monitored structural details in view of fatigue tracking have been continued i.e. there are now more structural details under monitoring than that reported earlier in ICAF 2009 Chapter 13.2.2.5. The co-operation between Patria and VTT has continued to new (un-instrumented) structural areas of interest of the FINAF F-18 aircraft: Patria has exploited their FE models and developed the associated transfer functions from the instrumented strain gage locations to the selected non-instrumented locations of interest. VTT then integrated these data into the HOLM ground analysis environment. There is now the capability to analyze 24 non-instrumented locations in addition to those with strain gauges / 38/.

### 13.2.2.5 The Hawk OLM program

Previous activities related to the operational loads monitoring (OLM) program of the FINAF Hawks, and the termination of the OLM, is highlighted in previous ICAF reviews e.g. / 20, Chapter 13.2.2.6/.

#### 13.2.2.5.1 Structural-specific life consumption metrics (Hawk) and Kauhava-based flying

The analysis of the two Hawk flights in view of tailplane stressing was continued further / 20, Chapter 13.2.2.6.2/ when selected flight maneuvers that damage the Hawk tailplane were visualized so that the cumulative damage values of selected strain gauge channels were shown simultaneously, see **Figure 13** and **Figure 14** / 22/.

The software development of the Flight Analyzer started at VTT in 2005. With the Flight Analyzer, the calculated damage values of user selected structural locations in user selected flights can be analyzed in detail. The causal connections to the structural damages can thus be studied with the aid of selected flight parameters. The selected parts of flight in turn can be visualized which helps further to illustrate the damaging maneuvers. The HOLM analyses are straightforward compared to the OLM analyses where the aircraft position information has to be produced separately with a Matlab tool. Some of the tools in the Flight Analyzer can be applied to other purposes as well and not exclusively for flight analyzing.

Today, The Flight Analyzer v2.0 software and its software documentation are tailored for the many analyses of HOLM and OLM data. A manual for the Flight Analyzer and visualization tool / 23/ was written at the same time period because of the mutual benefits of writing it simultaneously with the aforementioned research activity / 22/.

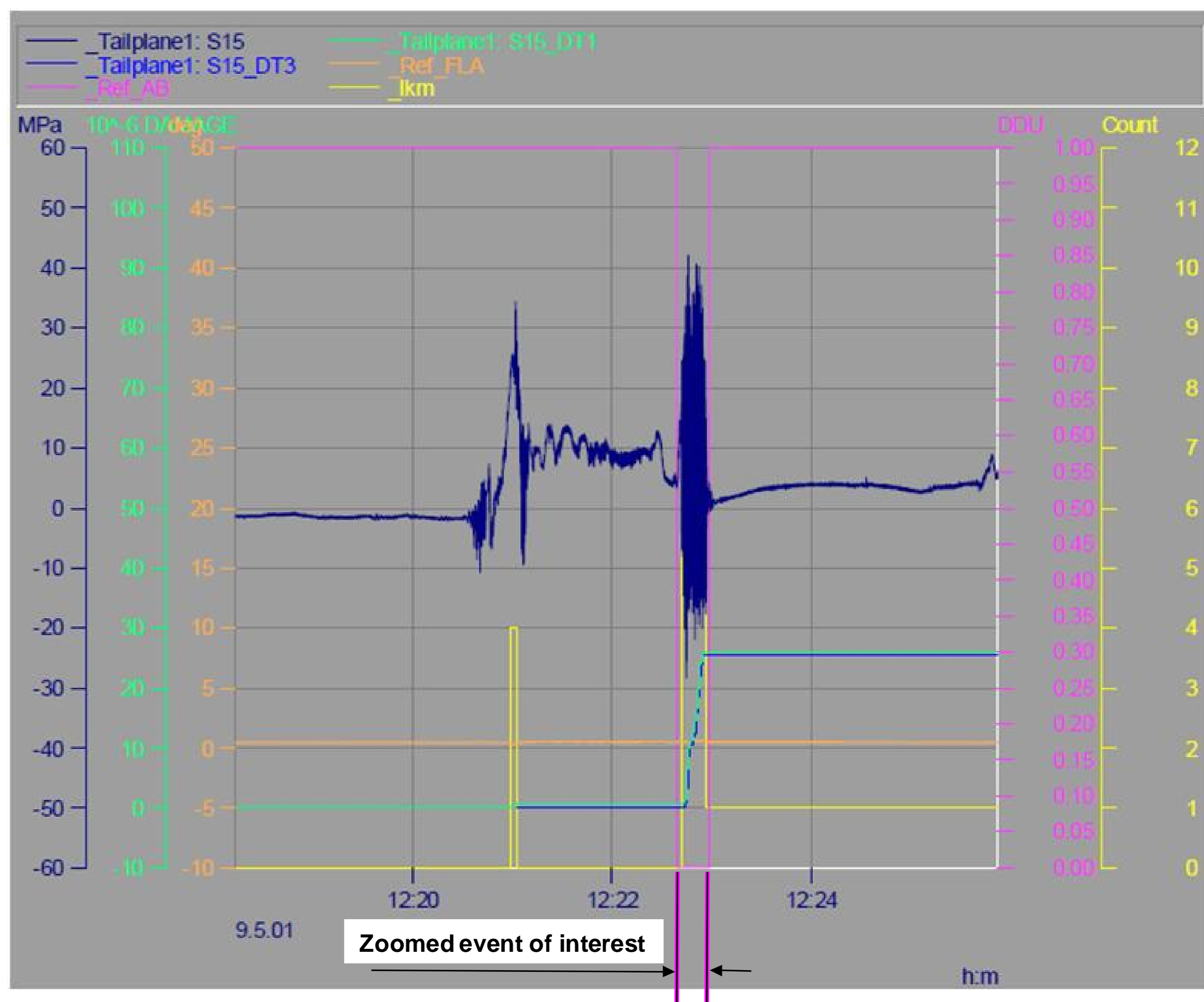

**Figure 13:** From an interesting flight, a segment of 8 seconds in length is shown, from which the event responsible for fatigue damage accumulation for a given structural detail is zoomed for visualization. Picture by courtesy of VTT.



**Figure 14:** A snapshot from the visualization from the zoomed event of interest from Figure 13. **Upper right:** The analyst can follow the real time damage accumulation of several structural locations (4 locations shown) as the flight progresses. **Upper left:** Associated flight parameters are shown via the HUD (head-up display), which can be tailored as per the analysis needs. **Lower right:** Real time pilot controls (stick and pedals movements, throttle position) provide the analyst information on what the pilot was doing. Picture by courtesy of VTT.

The FINAF Hawk fleet has been based in Kauhava since the end of 2005. As defined in / 20, Chapter 13.2.2.6.2/, a research was conducted to find out the increase in the structural fatigue life consumption after year 2005 / 55/. The existing OLM data (a total of 1 300+ analyzed and reported OLM flight, both before and after concentrating Hawks to Kauhava air base) and flight reports (LSI) were used as the basis of the research.

Structural fatigue life consumption data (OLM) and FI consumption (on the basis of g counts) results were compared with each other both prior to Kauhava era and after all Hawks were concentrated at Kauhava. From the 1 300+ flights database, the recorded OLM data representing Kauhava usage is unfortunately scarce compared to data before Kauhava-based flying. Thus, no definite and final correlations between OLM and FI could be made. The same report includes also defining for the structural-specific life consumption metrics for the Hawk tailplane.

#### 13.2.2.5.2 Towards Hawk Mk.51 Upgrade 2 (UG2)

Patria is currently upgrading the FINAF Hawk fleet (18 Mk.66 jets, 7 MK.51A jets and 1 MK.51 jet). Upgrading is done to further increase the quality and efficiency of fighter training. Before the UG2 decisions in 2009 there were plans to re-engineer the OLM system into a reduced system for the UG2 modification (glass cockpit). The existing onboard OLM suite (strain gages, onboard data storage unit, etc.) and the associated ground systems were critically reviewed / 49/ / 62/.

Based on the OLM/HOLM experiences, the aim was to upgrade the OLM system technically closer to the proven high quality HOLM system while maximizing the comparability between the old (the 1300+ flights database created with the now deceased OLM system) and the new UG2 OLM future flights. The unnecessary strain gages were identified, and suggestions were made to either remove them entirely or replace some of them with new locations. The ground system hardware and the associated analysis procedures were also reviewed in view of UG2 OLM / 62/. The onboard data storage and acquisition system was redesigned, aiming at maximizing the experience-based benefits from the HOLM system, to come up with a suggestion to have a

commercial-off-the-shelf solution to be applied on designated aircraft (Mk.51A/Mk.66) / 49/. These plans were later replaced with an alternate system, described below.

### 13.2.2.6 Research efforts towards an OLM replacement system (Hawk Upgrade 2)

#### 13.2.2.6.1 Structural data acquisition system (ESDA)

The Hawk Mk.66's that the FINAF purchased from Switzerland were equipped with the electronic structural data acquisition system (ESDA). The original ESDA was developed by Spectralab and supported and operated by RUAG; former not existing and latter without activities in the field of Hawk anymore. As the FINAF would like to follow the fatigue wear of the Mk.66's, a domestic project was started to study if Emmecon's strain measuring and analysis techniques could be utilized for this purpose. Emmecon has two processor platforms as candidates to this application named MK66-SHM; the stronger platform is based on powerful ARM/Cortex-processor running Linux operating system. When operational, the system continuously measures strain and classifies it with the Rainflow algorithm. The strain data is combined with aircraft configuration, basic flight parameters and weight information after which all data is stored with time stamps to a mass memory.

After flight the data can be transferred to a ground station (e.g. a laptop) via Ethernet in any office network or via USB. In the MK66 SHM module there is also a RS-485 bus to connect the mission computer, and a CAN bus to connect Emmecon's automated and structure integrated eddy current inspection system. MK66 SHM's digital inputs can be used to gather data about external loads connected to pylons and analogue inputs to measure g-forces from an external sensor or fuel level. The module itself has an internal 3-axis accelerometer.

#### 13.2.2.6.2 Integrated eddy current inspection system for FINAF Hawks

Emmecon has also developed an eddy current inspection system (EDDY) which is integrated onto the structure and executes automated inspection sequence upon request or automatically. The system will be tested with simplified test specimen simulating a butt strap joint in Hawk's tailplane; this test is similar to the one presented in / 16, Chapter 4.2.4/.

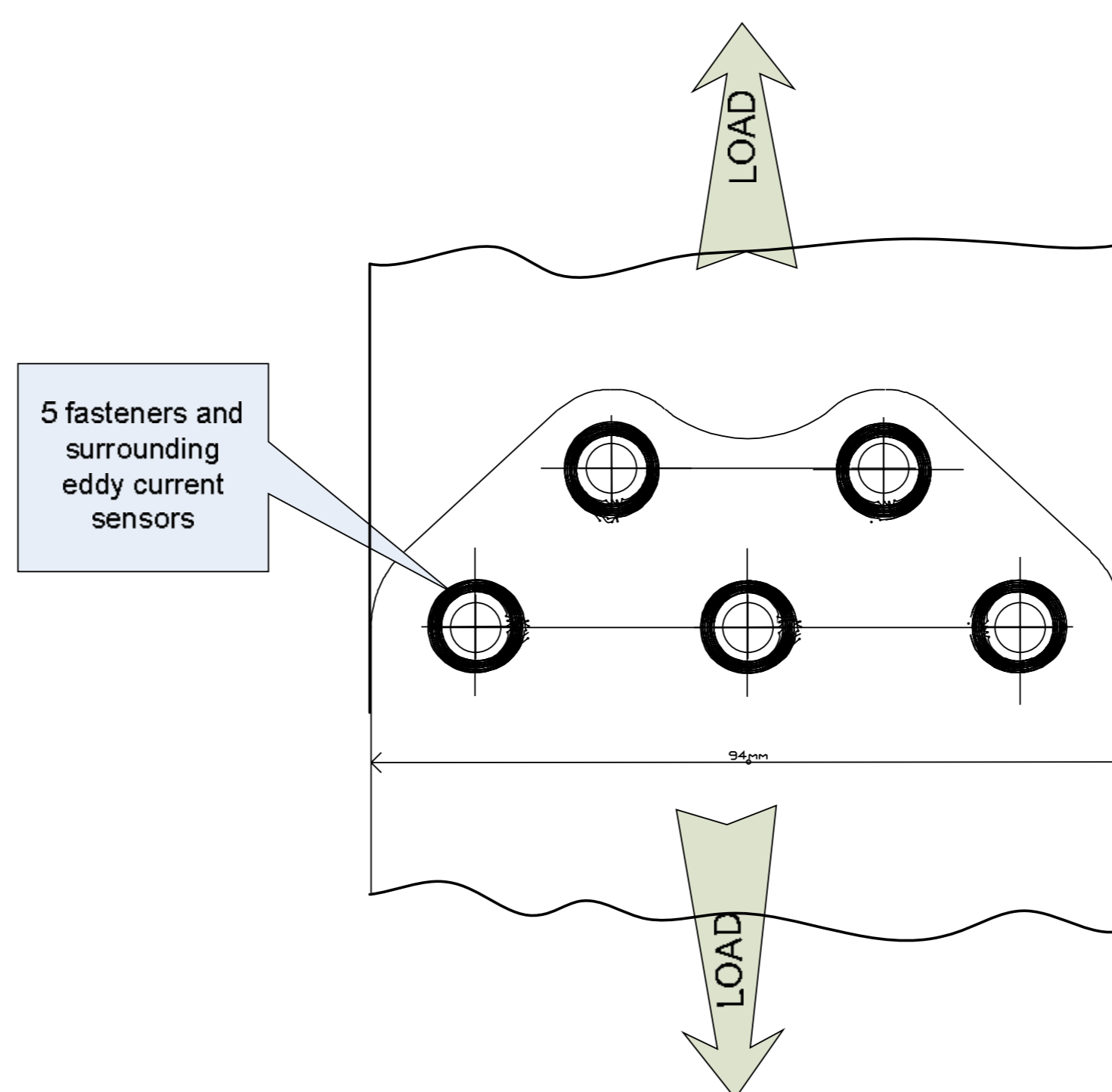

**Figure 15:** A specimen with five fasteners with an eddy current sensor (printed circuit board, PCB) around each fastener. Picture by courtesy of Emmecon Ltd.

As illustrated in **Figure 15**, there are five fasteners with an eddy current sensor on the specimen. A sensor is actually one printed circuit board (PCB) which is glued on the surface of the specimen. When connected to a ground station PC (see **Figure 16**), the PC makes a connection to MK66-

SHM through Ethernet which in turn forwards requests and commands originating from the PC's application program to the EDDY-module through the CAN bus. When initiating the process, the PC first identifies the system and sensors connected – each electronic module (SHM or EDDY) and sensor has a unique ID. The PC establishes a connection to a remote database (DB) to fetch the measuring parameters with the matching ID-numbers that were read from the connected system. The PC commands the EDDY-module (through Ethernet or CAN) to perform measurements with parameters fetched from the DB. The database is Microsoft's MS-SQL (structured query language) and the internet connection to the DB can be established with any interface available: LAN, WLAN, GPRS-dongle etc. The EDDY-module replies with the measuring results which the PC stores to the DB. The measured data can be fetched from the DB and analyzed later. The system has been successfully tested to detect surface cracks in a riveted test specimen.

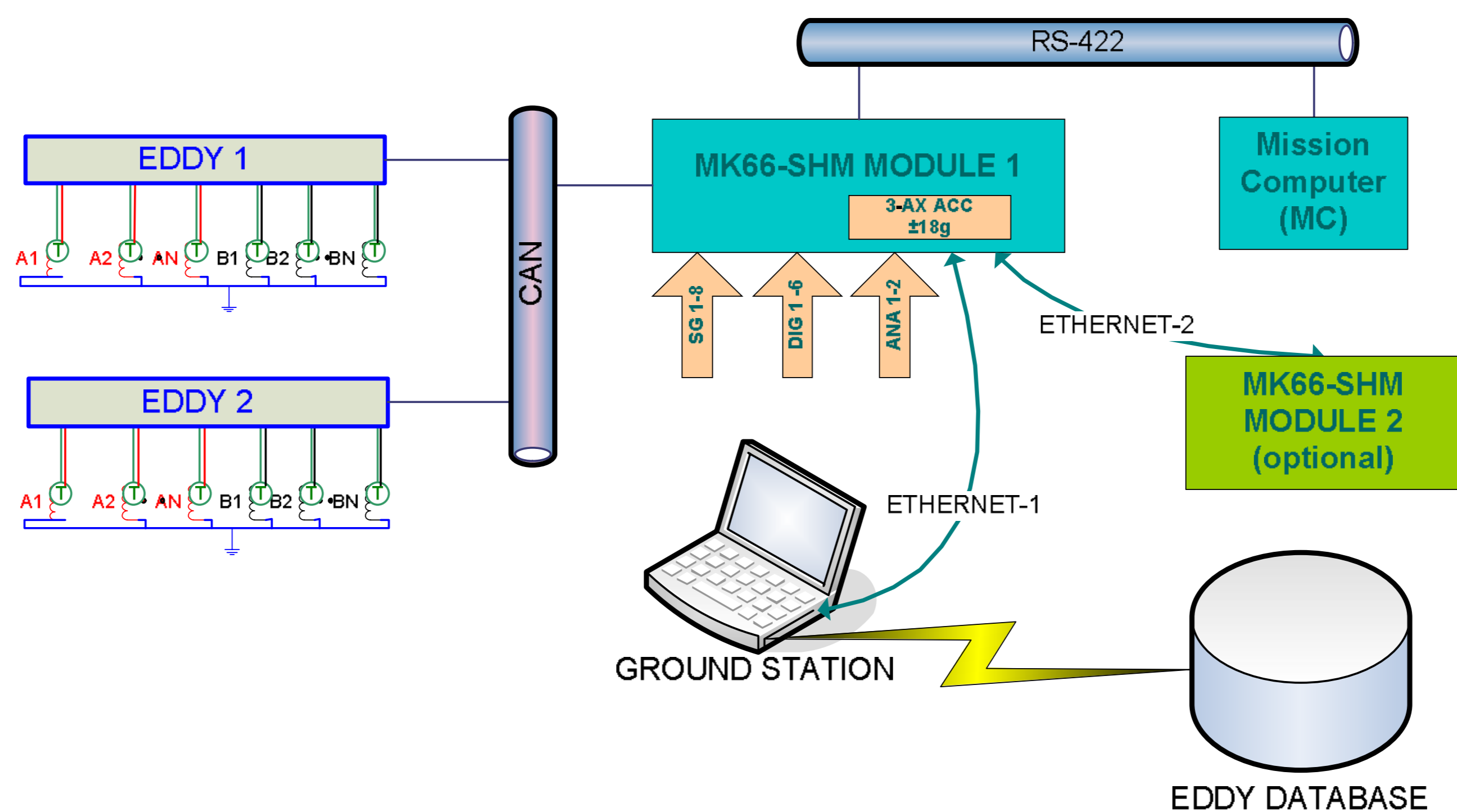

**Figure 16:** Eddy current inspection system (EDDY). Picture by courtesy of Emmecon Ltd.

### 13.2.3 Structural integrity of composite materials

#### 13.2.3.1 Thermographic studies – update

Penetrated water in the composite sandwich structures causes problems in aircraft structures and this has been a research activity at VTT for several years by now. There have been a few cases in the world where for example flight surfaces have been lost during a flight, because moisture has corroded the honeycomb structure and further reduced the strength of the adhesive. Water can also cause additional defects during composite repairs, which have resulted in the expansion of the moisture (in closed cavity), hence causing skin blow core phenomena during the curing cycle (heating) of the repair.

Previous research efforts on the development of thermographic inspection routine exploiting phase transition of water for moisture detection in aircraft structures have been reported in ICAF 2009 Chapter 13.2.3.1. Thermographic research has continued in co-operation with the FINAF and VTT in the area of F-18 composite structures. Reliability and routine of the thermographic inspection method based on the phase transition of the water has been further developed since 2009. The inspection method is such that the whole structure is first cooled below the freezing point of water (e.g. the aircraft is stored outdoors instead of in a hangar over the night when the weather is cold enough) before warming the structure in room temperature and the inspections are done during the warm-up period.

Effects of the environmental conditions have been found to be very challenging as several factors affect the inspection. The main effort in the research has been put on finding the reliable testing



conditions and routines for the inspection method to detect the penetrated moisture in real aircraft parts. Effect of environmental conditions and the inspection method is reported in / 59/.

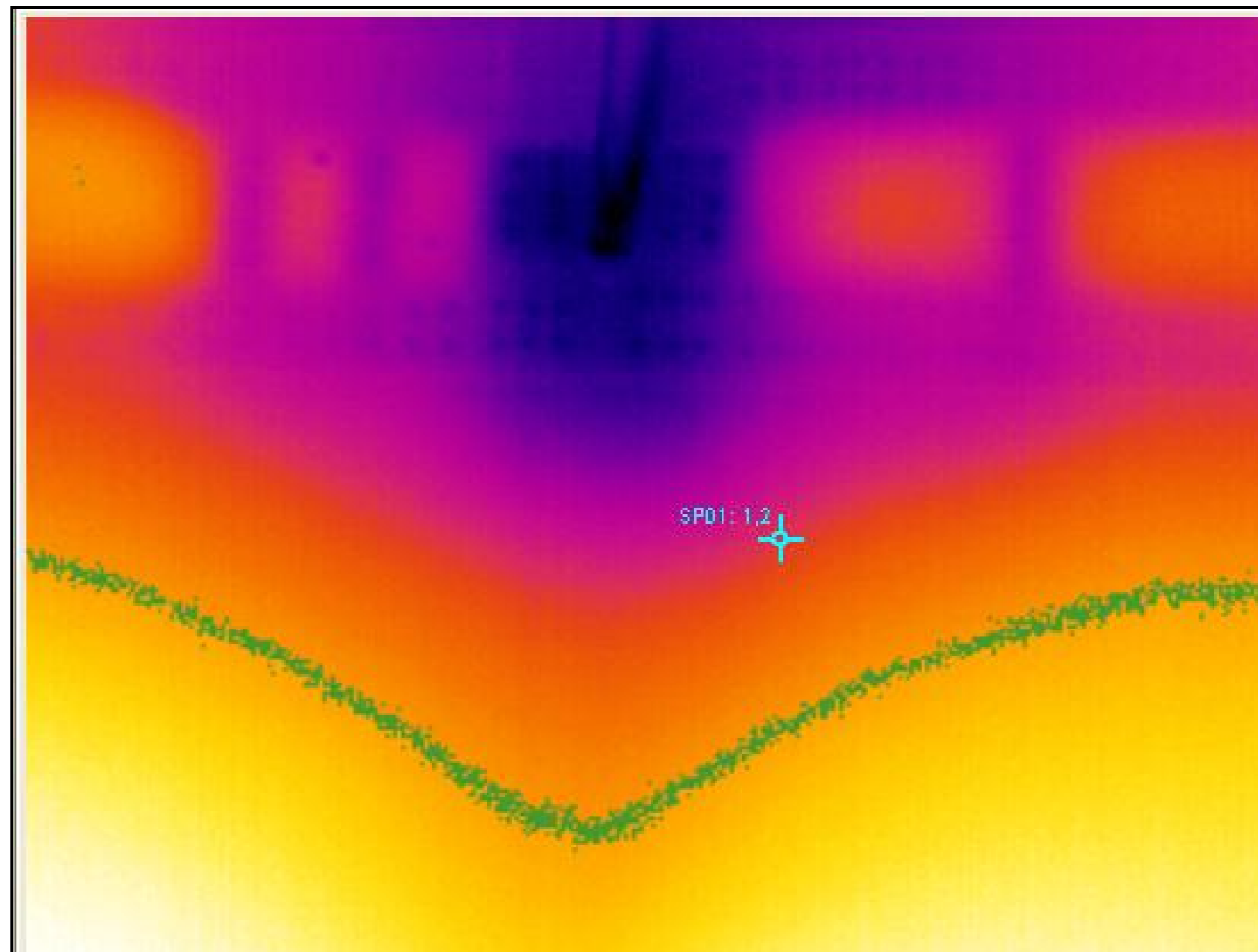

**Figure 17:** *Thermographic inspection of F-18 trailing edge flap (middle hinge) at optimal inspection time (non-defected structure). Picture by courtesy of VTT.*

Earlier investigations to determine optimal inspection time were mainly done with aircraft parts removed from the service. Their analyses provided a rough estimation of the optimal inspection time for each inspected part. The effect of fuselage and stores configuration of the aircraft was investigated with numerous tests to determine the optimal inspection time accurately for each condition.



**Figure 18:** *The optimal thermographic inspection exploiting phase transition of water: the inspection consists of six different flight surfaces (10 locations) in a sequence of inspection checks.*

Latest results have showed that six (6) flight surfaces, which mean ten (10) inspection locations in total, can be inspected in one sequence of inspection checks at an optimal temperature range with the developed thermographic method (**Figure 18**). The sequence consists of rudder, trailing edge flap (around the middle and the main ladder hinges) and horizontal stabilizer (pinion and main ladder hinge) from both sides of the aircraft.

Further work will concentrate on preparing the specifications and working routines for each Air Command operating the FINAF F-18 jets.

### 13.2.3.2 Strength prediction of impact damaged laminates in multiaxial in-plane loading

Previous research efforts on composite laminates have been reported in ICAF 2009 Chapter 13.2.3.4. The residual strength of impact damaged laminates is typically defined using compression after impact (CAI) test standard that is based on uniaxial compression loading. Analysis methods are developed to model the behavior of CAI specimens and they are found to work well [74]. In practice the composite structures are in multiaxial loading conditions. Therefore, the applicability of the analysis methods is very limited.

The analysis of the residual strength of the impact damaged composite structures requires that the analysis method takes into account the arbitrary in-plane loading conditions. General composite analysis software such as ESAComp include notched laminate analysis module. These analysis methods are typically based on point stress analysis and on the use of characteristic distance. Point stress analysis is possible to fit into a specific test data but is not necessarily applicable to other laminate lay-ups, notch geometries or loading conditions.

An analysis method was developed that enables the residual strength estimation using arbitrary in-plane loading, **Figure 19**. The work is based on existing analysis methods which are combined to produce more general analysis method for impact damaged laminates [75] [76]. The analysis approach is based on equivalent hole and the use of characteristic distance. The applicability of the analysis method is first compared to previous test results of quasi-isotropic notched laminates. Additional tests are performed using laminates with different lay-ups. These laminate lay-ups include balanced laminates without any  $0^\circ$  plies. Although the tests are performed in uniaxial external compression loading all plies are in multiaxial stress state. This allows the use of existing CAI test arrangements. The results obtained from these tests provide a valuable tool for multiaxial strength analysis of impact damaged composite laminates. In addition to the tests performed, the test arrangements for biaxial loading of specimens were designed [11].

The analysis method used in this study is a very useful tool for estimating compression loaded laminates with various lay-ups. It is possible to extend the method to cover also multiaxial external load cases.

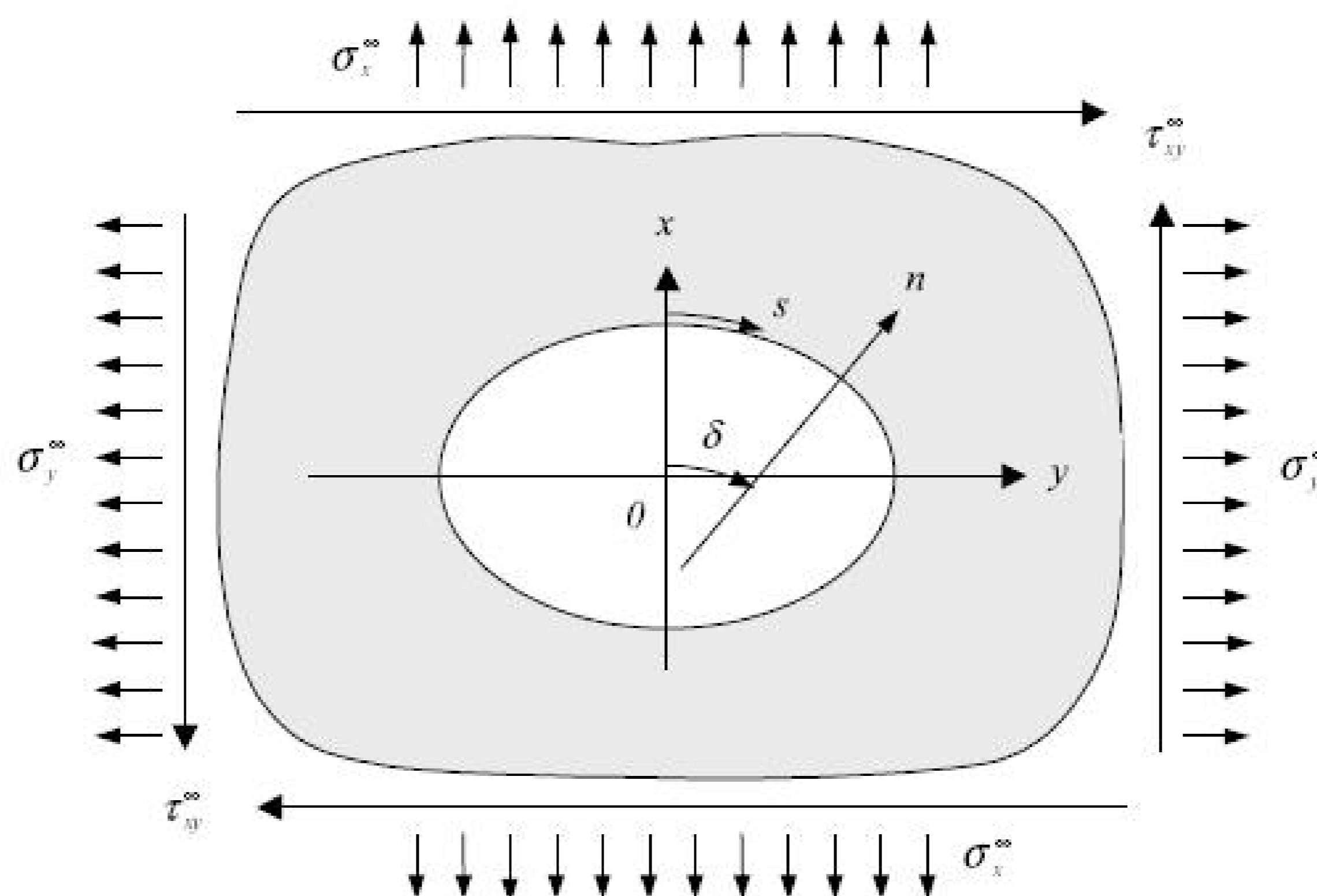

**Figure 19:** General in-plane loading of arbitrary elliptical hole. Picture by courtesy of Aalto University.

### 13.2.3.3 Fracture mechanics based analysis of delamination

Previous fracture mechanics-based studies on composite structures were highlighted in ICAF 2009 Chapter 13.2.3.5. The work on numerical fracture mechanics was started as a master's thesis project [26]. The initial work concentrated on virtual crack closure technique (VCCT) and its use in composite structures. The work was continued and also the cohesive elements were reviewed. The

software tool used in the work was ABAQUS. The experimental work started also as a master's thesis project / 10/ / 12/.

The effect of analysis parameters i.e. element type, mesh density, material properties and other analysis method dependent parameters were studied using both methods separately. The test cases used in the study were DCB and ENF specimens corresponding to modes I and II respectively. The uniformity of the GI or GII distributions through the width of the specimen was studied with respect to the change of different analysis parameters. All analyses were performed using both 2D and 3D elements. The 3D elements include shell, solid and continuum shell elements. Analytical methods are used also as a reference. Based on the work a solid foundation to the use of fracture mechanics based analysis of real life structures was obtained. / 27/ / 28/ / 29/

The current work concentrates on the following fundamental questions:

- Will the delamination grow with applied service loads?
- Is the growth restricted to certain area with certain service loads?
- Is the delaminated structure able to sustain the service load when the delamination growth and the strength of sublaminates are taken into account?

The work is started using DCB and ENF specimens where the complex fracture phenomenon is modeled using 2D and 3D elements. The purpose is to model accurately the behavior of the test specimens without simplifications or averaging G-distributions through the width of the specimen. The work includes both adhesively bonded joints and laminated composite joint with various ply interfaces.

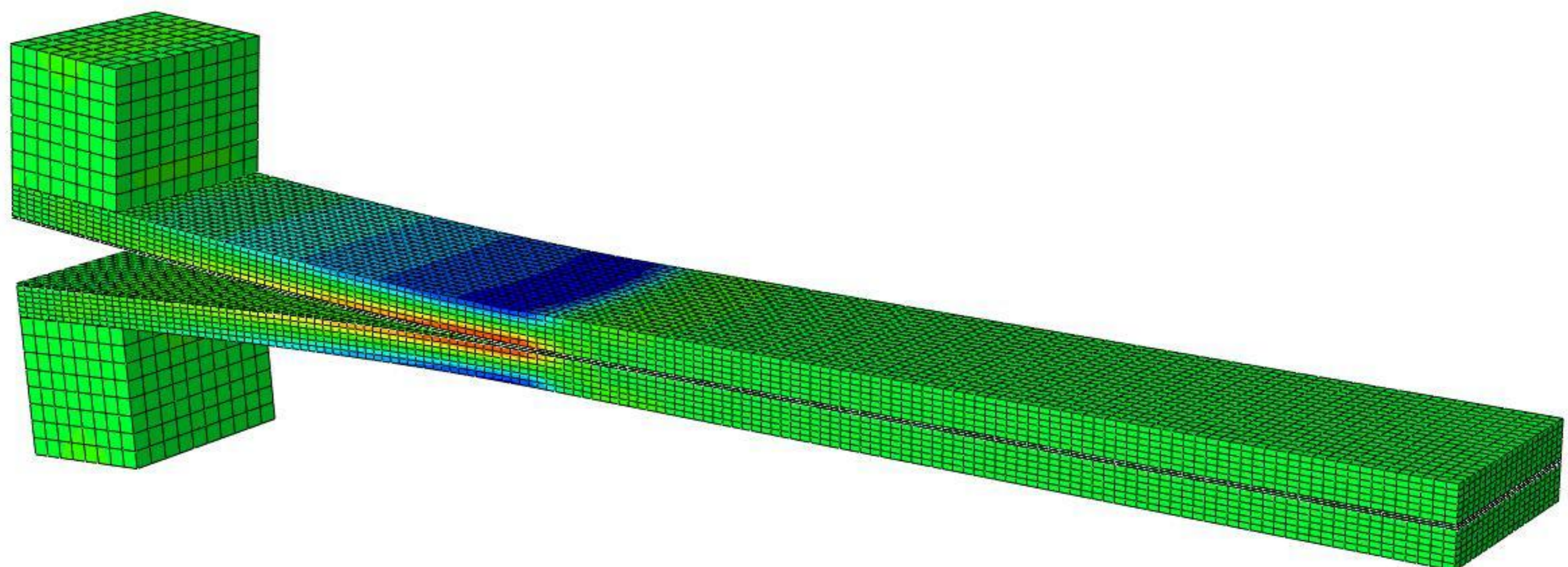

**Figure 20:** Numerical 3D element model of a DCB specimen. Picture by courtesy of Aalto University.

## 13.2.4 Structural integrity of metallic materials

Previous surface renewal activities have been reported in ICAF 2009 Chapter 13.2.4. The following summarizes the research efforts since the previous review.

### 13.2.4.1 Life improvement factor (LIF) of polished and shot-peened titanium alloy 6Al-4V

In the FINAF F-18 Structural Refurbishment Program there are quite a few locations where polishing is used to extend critical locations' fatigue life. Polishing is an effective method to improve fatigue life of aluminum alloys in lower stress ratios / 44/ but the method is very labor intensive. If the same life improvement factor (LIF) could be achieved with a less labor intensive method, e.g. a manual or robotized shot peening method, there could be significant save of time and reduction in cost of work. Repeatability can also be improved with robotized process instead of hand work.

Test results for LIF's of polishing and shot peening in aluminum alloys have been tested and reported numerous times in the aerospace industry, but comparative LIF's for polishing and shot peening of titanium alloys do not seem to be available in the open literature.

Patria conducted a coupon test program in co-operation with HUT (currently Aalto University), where the effect of polishing and shot peening of 0.078 in (2,0 mm) thick titanium alloy 6Al-4V specimens were tested. Test series for titanium alloy consisted of three series (baseline, shot peened and polished coupons) with 12 test coupons in each series. Stress ratio for all test series was  $R = -0,2$ . Complete test plan for this titanium coupon testing is presented in / 46/.

The LIFs in the order of 5 were obtained for the polished and shot peened titanium alloy coupons. At the same time, one specimen from both series cracked in the amount of cycles corresponding to the base material results. That causes more scatter to the results and leads possibly to further investigation of the tested material. However, these test results justify the process change on one of the FINAF F-18 Structural Refurbishment items from polishing to shot peening. Full report on test results is presented in / 48/.

### 13.2.4.2 The effect of the alodine chromate conversion for the aluminum structure fatigue life

The effect of the alodine chromate conversion for the aluminum structure fatigue life was investigated. That test series was made because the alodine treatment is widely used in different FINAF F-18 refurbishment projects. The fatigue tests were made using alodine treated Al 7075-T76 specimens. The specimen geometry and tested stress levels were equal to the geometry and results presented in / 45/ and thus the comparability for the earlier test results remains.

The main conclusion was that the alodine chromate conversion treatment does not decrease the aluminum structure fatigue life, if the surface treatment process is made according to Patria's process specifications. Full report on test results is presented in / 48/.

### 13.2.4.3 FINAF F-18 and Hawk structural integrity manuals

The fatigue management policies of the FINAF have been outlined in previous national reviews, for example in ICAF 2009 Chapter 13.2.4.5. The tools and instructions for the ASIMP documentation for the fatigue life cycle management of the Hawks (meeting the requirements for the remaining post-midlife structural integrity issues) and Hornets (structural lifing policy and damage tolerance aspects) have been developed by Patria. The following provides an update.

Patria Aviation has created handbooks that describe the structural integrity management plans for the FINAF F-18 Hornet and BAe Hawk fleets. These handbooks are in two volumes, the first of which explains the structural integrity program and the second describes the actual management plan for each part of the aircraft structure. The intention has been to collect Hornet and Hawk fleet structural integrity policies and efforts into complete data sets, in order to make the fleet

management planning and structural maintenance and inspection planning tasks easier. The structural integrity program has been created using the framework of MIL-STD-1530C Aircraft Structural Integrity Program (ASIP).

The handbooks for Hornet will be published as a FINAF manual HN1-110-01S1 / 13/ / 14/. The Hawk handbooks shall also to be published as a FINAF manual-based, content on Patria Aviation's report numbers HW-L-104A / 33/ and HW-L-105A / 34/.

#### 13.2.4.4 Non-destructive inspection (NDI) activities (metallic materials)

Previous non-destructive inspection (NDI) research activities to support the in-service inspections of the FINAF F-18 Hornets (metallic parts) have been reported in ICAF 2009 Chapter 13.2.4.6. Activities since then are reported below.

##### 13.2.4.4.1 Experimental study of the sensitivity of the crack detection techniques applicable in the periodic in-service inspections using reference specimens

In this study, the sensitivity and application potential of the ultrasonic (UT) and eddy current (ET) techniques aimed at aeronautical applications were studied / 40/. The chosen NDT techniques and materials of the reference specimens with artificial flaws were such selected that they could be applied in the in-service inspection of the F-18 Hornets. The studied mechanized and manual NDT techniques included immersion and contact ultrasonic techniques exploiting Rayleigh waves and several eddy current techniques aimed at the detection of small (under 1 mm) fatigue cracks.

The goal was to develop the non-destructive examination techniques applicable during the in-service inspection of FINAF F-18 Hornets. The following sub goals were stated:

- study the sensitivity of the material transducer (special application of the Rayleigh waves), immersion and contact techniques. The flaws *under* the transducer can be detected;
- study the sensitivity achieved by the ordinary unfocused Rayleigh wave transducer (refraction angle in the component to be studied 90°), contact techniques. The flaws *under* the transducer and *in front* of the transducer can be detected;
- study the high frequency eddy current technique;
- study the effect of the painting of the part to be inspected (the painting layer is between the transducer and the inspected part) on the achieved examination sensitivity.

In the ultrasonic test of planar taped surface the highest signal to noise ratio of the indication due to the notch (0.1 mm x 1 mm) was 7.1. The 12 MHz material transducer was applied. The highest signal to noise ratio achieved in eddy current test was 10, see **Figure 21**. The shielded differential small diameter transducer was applied.

In the manual ultrasonic test of the inner corner of the L-profile the signal to noise ratio of the indication due to the 0.2 mm x 1 mm notch was 6. The highest achieved signal to noise ratio in the eddy current test was 30.

In the eddy current test of edge of the rectangular specimen the highest signal to noise ratio of the indication due to the 0.5 mm x 0.5 mm corner notch was 34. The increase of the notch width changed considerably the amplitude and the phase angle on the indications.

**Signal to noise ratio versus notch length, diameters of differential probe coils 0.5 x 1 and 1 x 2 mm, frequency 0,5 MHz**

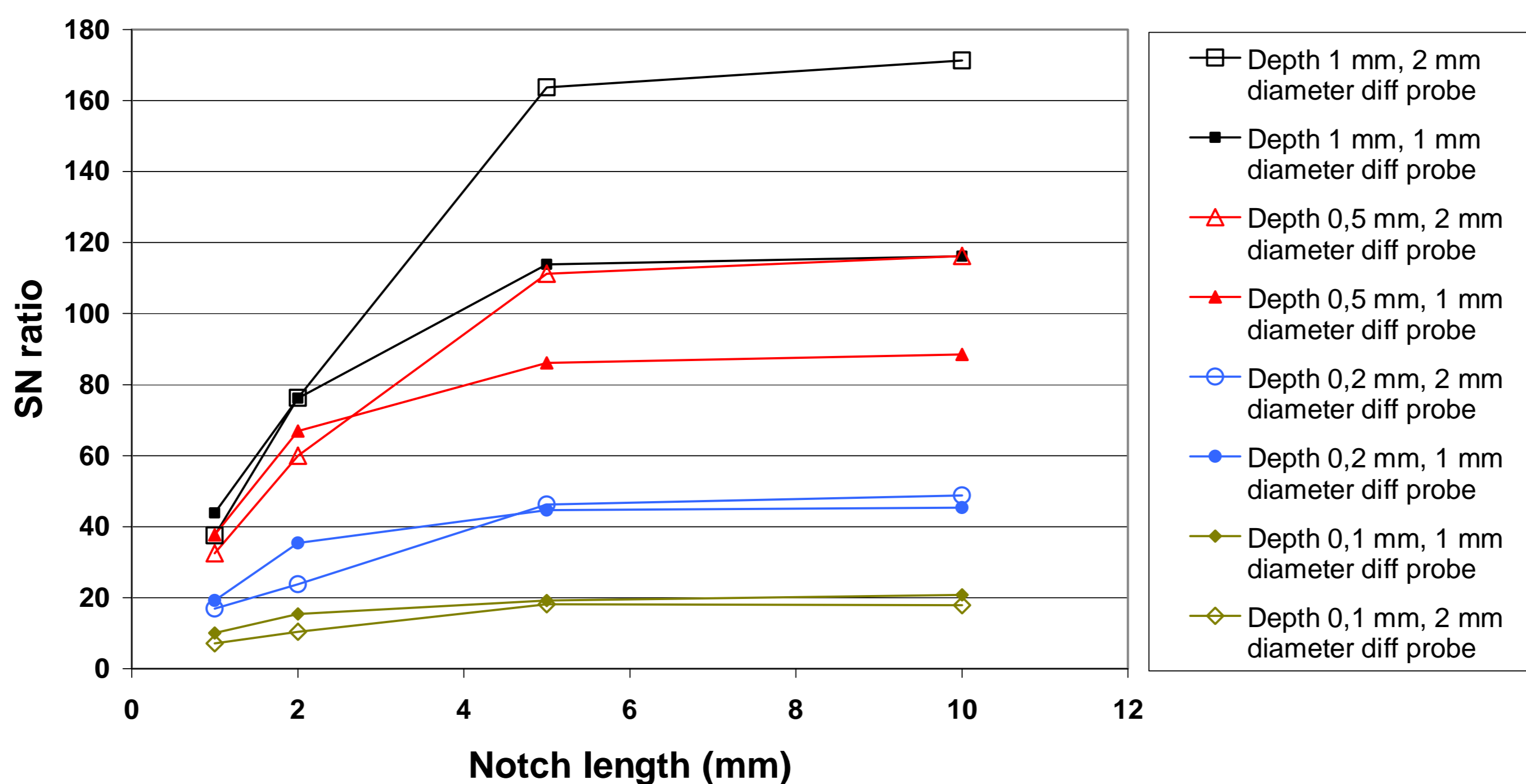

**Figure 21:** Signal to noise ratio of the notch indications versus the length of the uncorroded notches of the specimen 1. Picture by courtesy of VTT.

#### 13.2.4.4.2 Experimental study of the sensitivity of the crack detection techniques applicable in the periodic in-service inspections using unpainted and painted test specimen with real fatigue cracks

The goal of the experiments was to study the sensitivity of non-destructive examination techniques applicable during the in-service inspection of FINAF F-18 Hornets. More specifically:

- the effect of repair painting to the achieved sensitivity in ultrasonic testing (UT) when material transducers (special application of the Rayleigh waves) are used. Immersion and contact techniques were studied;
- comparisons between the true crack size and the size estimated from the UT and ET indications using **a)** reference flaws in reference specimens and **b)** the results of destructive test of the test specimen with real fatigue cracks.

The UT/Rayleigh, (both “immersed” and “contact” techniques) and several ET techniques were applied to laboratory test coupons, which had already been loaded to failure (complete separation) / 41/. These coupons contained multiple secondary cracks (primary interest of this study) adjacent to the killer crack (ignored in this study). The test coupons were inspected in two surface conditions: as-is (unpainted i.e. without any surface preparations) painted (realistic i.e. repair painted as per Patria’s production specifications). The experimental comparisons included the comparisons to the previous efforts with artificial flaws (*Chapter 13.2.4.2*).

Examples of the achieved results using different ET and UT techniques are shown in *Figure 22* and *Figure 23*. When the coupons were painted the highest detection rate and the highest signal to noise ratio of crack indication was achieved with ET techniques. The 12 MHz UT technique was not applicable on the coated surface.

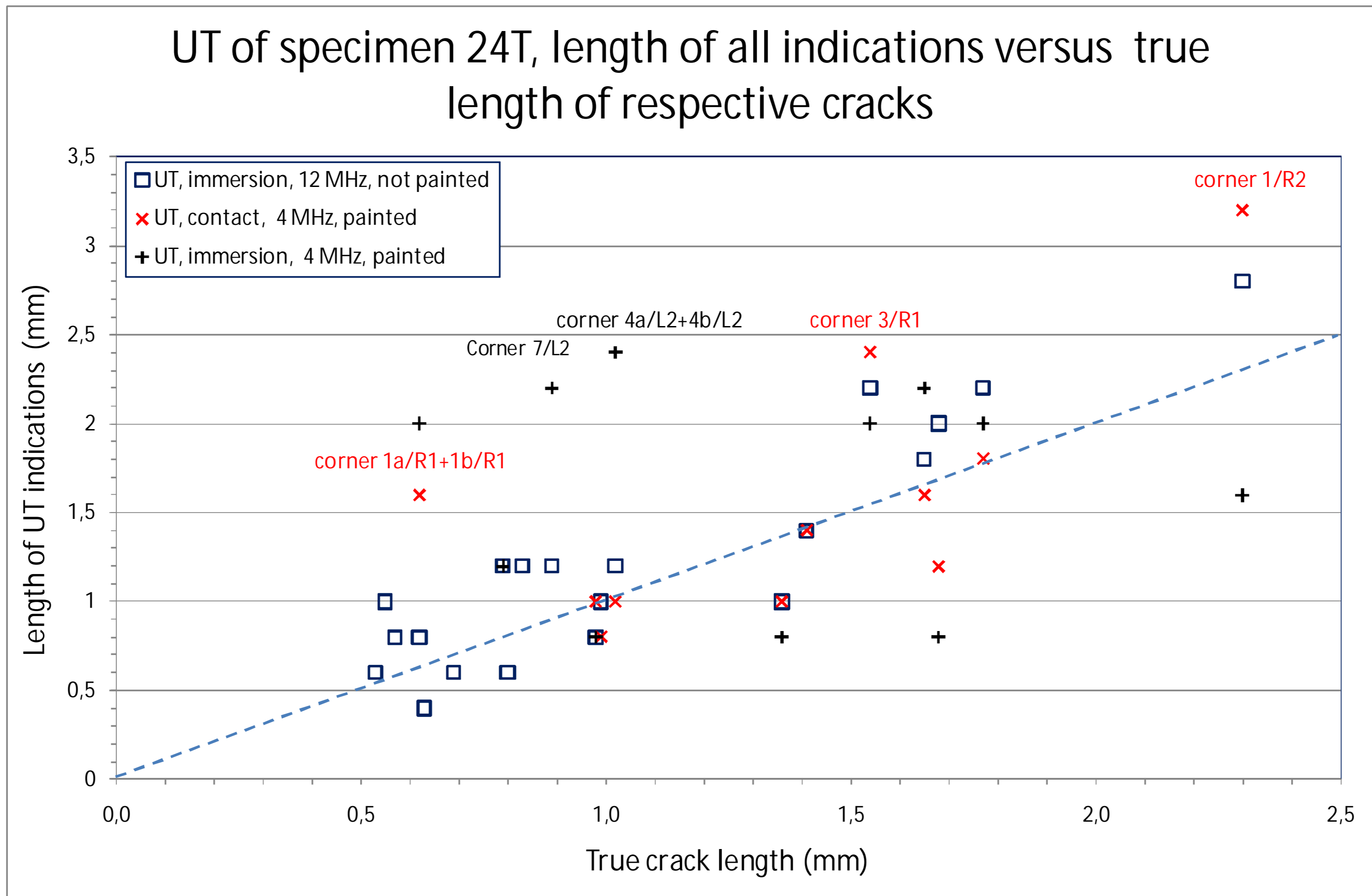

**Figure 22:** The specimen 24T, the UT length of all detected fatigue crack indications versus true length of cracks. 12 MHz immersion technique was applied before painting and 4 MHz contact and immersion technique were applied after painting. Picture by courtesy of VTT.

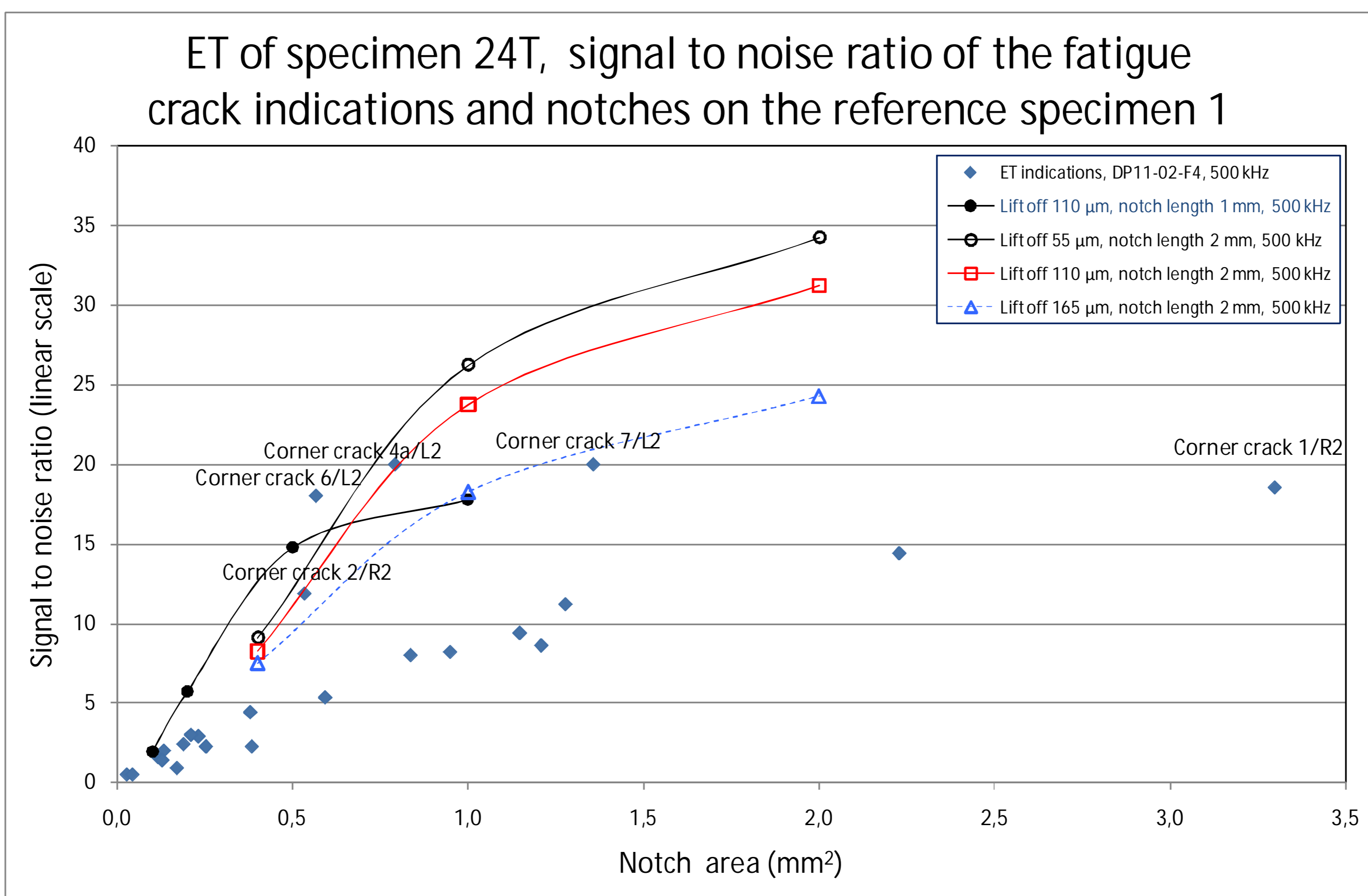

**Figure 23:** The signal to noise ratio of all fatigue crack indications detected from the R and L sides of the specimen 24T (blue dots  $\blacklozenge$ ). The four calibration curves were created using reference notches on planar area and different lift-off values (distance between the transducer and the surface). The transducer DP11-02-F4 was used. The applied ET frequency was 500 kHz. Picture by courtesy of VTT.

## 13.2.5 Repair technologies

### 13.2.5.1 Repair technologies for the FINAF F-18 metallic primary structures

#### 13.2.5.1.1 Proof-of-concept demonstration in laboratory conditions

Since the previous ICAF report / 20, Chapter 13.2.5.2/, the bonded boron fiber composite repair technology has been in focus at Patria Aviation where the repair technologies are investigated continuously for the applications in FINAF F-18's. Composite repair is one of the many repair technologies in use at Patria and in this research it was used on a metallic primary structure. The proof-of-concept testing was done in cooperation with (in alphabetical order): Aalto University, Patria Aviation and VTT.

The test specimens were described in / 20, Chapter 13.2.5.2/ where an I-type beam emulates a critical part of an F-18 Hornet fuselage bulkhead, *Figure 24*. These I-beams were designed by Patria Aviation and fatigue tested by VTT in two batches: without pre-fatiguing the structure (4 specimens with the composite patch and 4 without it) and as a pre-fatigued structure (3 specimens with the composite patch). The boron fiber composite patches were manufactured and installed to the test specimens by Aalto University. / 35/ / 36/

In the fatigue testing, the variable amplitude spectrum (load spectrum) used was created using the HOLM flight data with marker loads added to it. Eddy current and ultrasonic inspections were done both prior to fatigue tests and during the testing. The frequency of the tests between the spectrums varied depending on the case. Fractographic inspections were carried out. All the inspections were performed by VTT. / 37/

The results from the first test batch (8 specimens) were to confirm that the composite patch strengthened the structure and approximately doubles the fatigue life despite the pre-load caused by the curing of the adhesive. It was also evident based on the tests that the stiffness-strain ratio was more advantageous in the strengthened specimens. The ultrasonic tests revealed no debonding of the adhesive before the specimen broke. / 35/

The second part of the test series was done to simulate the actual repair process for an airframe with a significant amount of flight hours. The main result from the last three pre-fatigued specimen tests was demonstrating that if the composite patch is installed at 3000 airframe FH (FINAF average spectrum), the received life improvement factor (LIF) is still at least 1.3 times more compared to the specimens without the reinforcement. / 36/

These 11 fatigue test specimens are part of a test series where the proactive repair patching of a critical part of a bulkhead was validated.



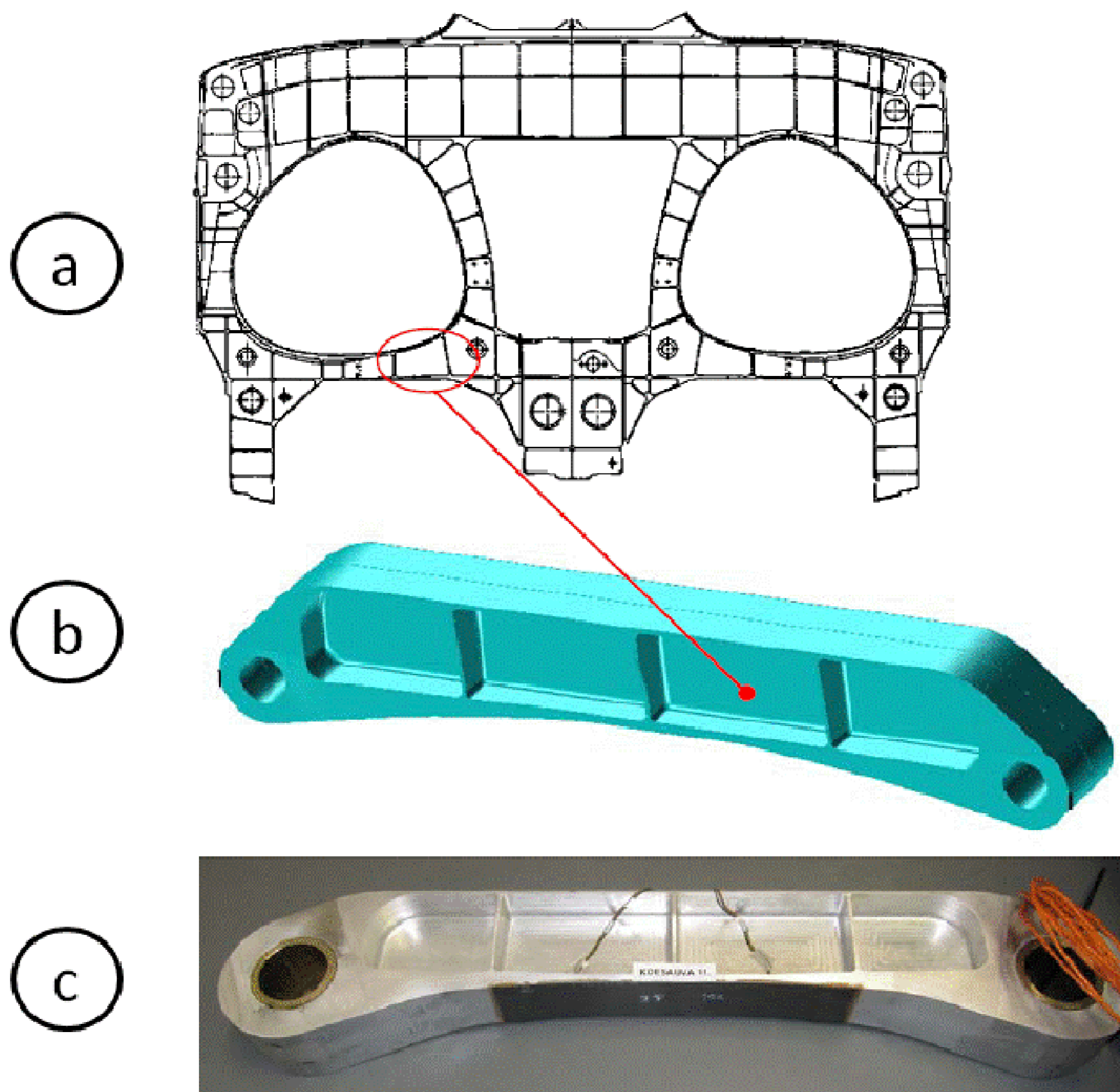
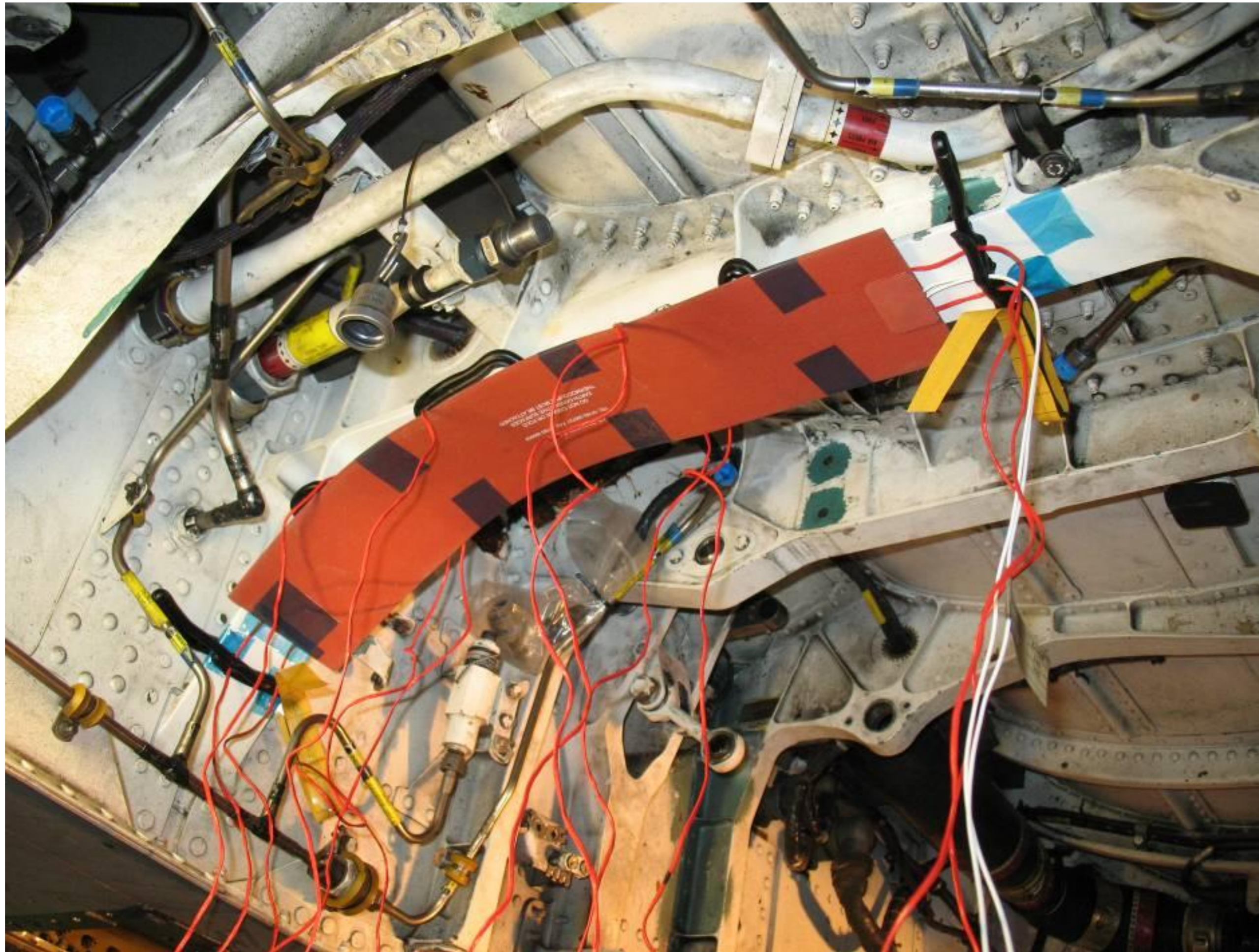

**Figure 24:** a) The fuselage bulkhead Y488 of the F-18 / 77; b) model of the specimen emulating the bulkhead; c) actual specimen (№ 11) with the composite patch. Picture by courtesy of Patria Aviation / VTT.

#### 13.2.5.1.2 Cure cycle testing of boron fiber patch (on-aircraft installation)

Patria has been testing boron fiber patch solution to extend the fatigue life of F-18 center fuselage bulkhead. Previous results from this research have been reported in ICAF 2009 Chapter 13.2.5.1. With the good results from the proof-of concept testing (*Chapter 13.2.5.1.1*), the FINAF decided to go ahead with the testing of actual installation of the planned design.

Work was started with heating experiments to assess patch bonding process feasibility and to gather information on the heat distribution and maximum temperatures of the structure during bonding process. This information was needed to assess the effect of elevated temperature to the strength. Tests were performed using a scrap ex-Canadian Forces F-18B 188920 center fuselage, which has similar geometry of the critical detail with FINAF F-18D, *Figure 25*.



**Figure 25:** Heating mat in place at Bulkhead Y488 in ex-Canadian Forces CF-188920 fuselage. Picture by courtesy of Patria Aviation.

Heating cycle for FM300-2 film adhesive and its primer was investigated. Heating cycle consists of 1-2 hours heating in 120 °C for the primer and 10 hours of heating in 100 °C for the film adhesive. Heat was introduced to the structure with heating mats, IR – lamps and ceramic heaters. Structure was monitored with thermal elements to measure and record the heat distribution in the repair area and surrounding structure.

Test was divided in five separate test points:

1. Basic heating of structure, vacuum bagged heating mat to 120 °C, to find out heat distribution in structure.
2. Heating to 120 °C with vacuum bagged heating mat and IR-heaters to simulate primers BR6747-1 or BR127 curing cycle.
3. Heating to 95 °C to simulate FM300-2 curing cycle.
4. Similar cycle with test point number three to verify repeatability of the curing cycle.
5. Heating to 120 °C with IR-heaters to simulate primer BR127 curing cycle.

Testing showed that the boron fiber patch can be cured on to the Bulkhead Y488 without excessive heat and related damage to surrounding structure. Preferred process was found to be silane pretreatment of aluminum used with primer BR127 with cure cycle near the lower temperature limit of 104 °C. Film adhesive FM300-2's cure cycle should also be within 90-100 °C temperature range / 39/.

### 13.2.6 Mechanical systems integrity

Research on the field of mechanical systems integrity is divided in three main areas: Simulation and modeling, laboratory and field testing and condition control and monitoring. Besides of research towards larger scale scientific goals some efforts are also focused into problem oriented smaller scale research subjects. Below is an overview of research areas, which is carried out in cooperation between the FINAF and TUT/IHA. Previous activities have been reported in ICAF 2009 Chapter 13.2.7.

### 13.2.6.1 Simulation and modeling

The main goal of the Simulation and modeling research is to improve understanding on the entire hydraulic system and its interconnections and interactions with other aircraft subsystems and structures. Another goal is the ability to simulate the functional characteristics of selected components and their modification alternatives from the viewpoint of the performance of the entire hydraulic system and ultimately the entire aircraft.

Hydraulic system modeling is done in two different levels of detail to enable studying both complete system and individual component levels with appropriate accuracy. Detailed analytical component models are developed for single component or partial system simulation for situations where point of interest lies in single component and high level of accuracy and detail is needed / 1/ / 8/ / 9/ / 15/. The complete system model, which is connected to the flight simulation model (HUTFLY2) in an interactive manner, utilizes simplified semi-empirical component models thus enabling model solving in real-time. HUTFLY2 is capable of producing simplified aerodynamic forces acting on flight control surfaces and also command values for hydraulic actuators. **Figure 26** shows the user interface of the combined model. A simulation environment utilizing distributed computing was developed to enable real-time solving of simulation models needed in hardware-/pilot-in-the-loop (HIL/PIL).

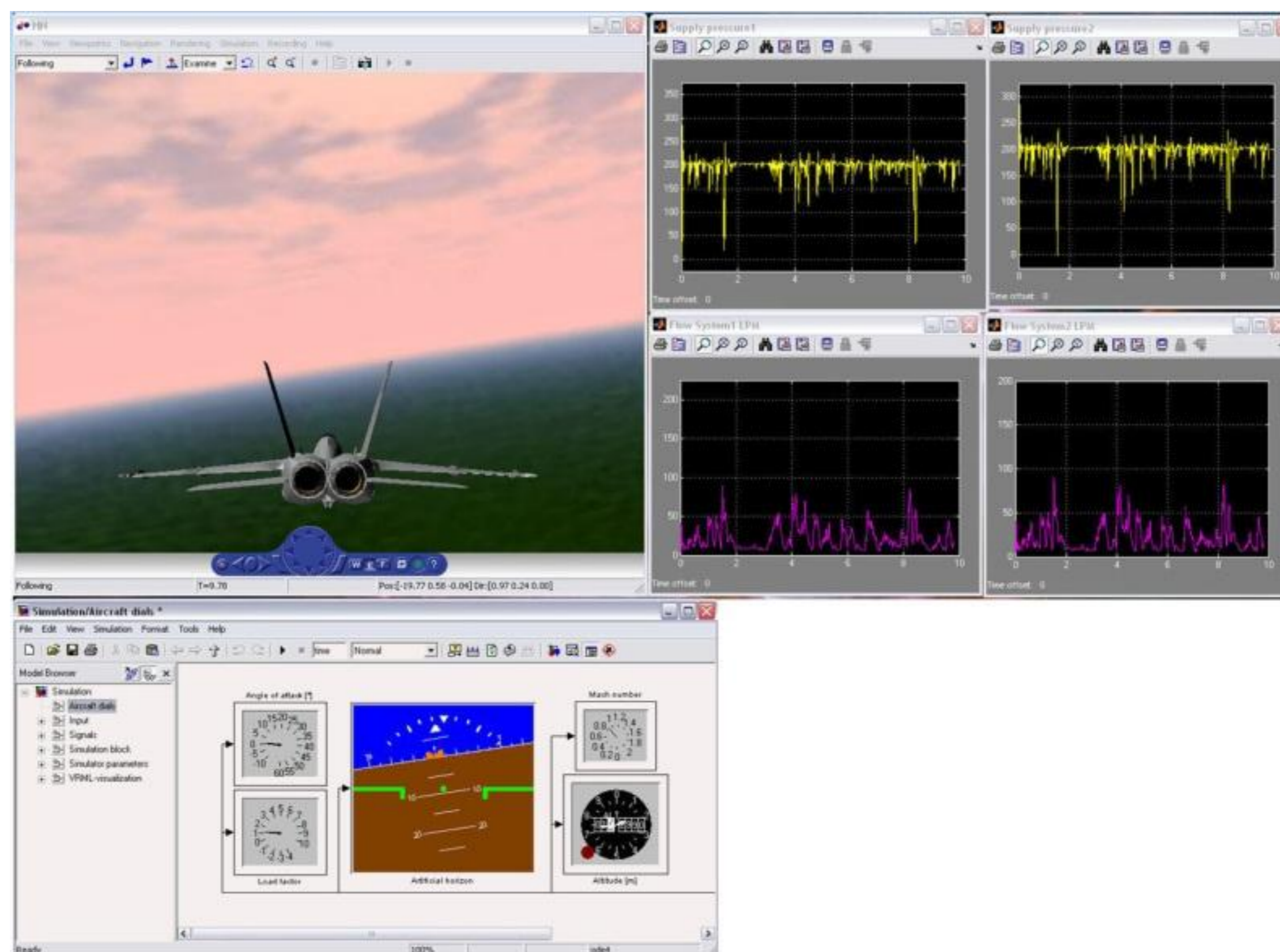

**Figure 26:** User interface of the combined 6 DOF flight model and hydraulic system models. Picture by courtesy of TUT/IHA.

### 13.2.6.2 Laboratory and field testing

The hardware-in-the-loop (HIL) interface can be used for including real components into the simulated system. The HIL interface transforms command values (produced by the flight simulation) into real-life command signals for the component and calculated loads into real-life loading forces. The loading force is produced by hydraulic servo actuator counteracting the real-life component. Hydraulic system variables (such as available flow rate, system pressure etc.) can also be varied according to instantaneous operating conditions of the hydraulic system calculated by the hydraulic system simulation model. Output parameters of the real component are measured and the HIL interface transmits the output parameters to system and flight simulations. The user interface and visualization give simplified possibilities for pilot-in-the-loop (PIL) simulations. Simulation can be controlled in real-time from a simple virtual cockpit.

The HIL simulation environment and simulation models together form a virtual ironbird which gives a possibility to study hydraulic system operation in an arbitrary in-flight operation point and arrange accelerated lifetime tests of components relatively easily.

### 13.2.6.3 Condition control and monitoring

Condition control and monitoring research is targeted into improving usability and reliability of aircraft hydraulic systems and also to lower maintenance costs involved. Research efforts in this field include:

- Monitoring the hydraulic fluid quality of the fleet and supporting equipment / 2/ / 72/ / 73/ and developing practices to improve it
- Testing hydraulic fluids to find variations in between different manufacturing brands and to find most suitable fluid
- Developing an inline hydraulic system condition monitoring unit.

The research of the inline condition monitoring unit is targeted into developing a hydraulic system condition monitoring unit based on COTS condition monitoring sensor technology (chemical quality sensors and particle counters). The unit is developed to be installed in portable test stands where it monitors the quality of the fluid returning from the aircraft's system and also the fluid quality in the test stand itself. Thus the unit will have two main applications: It can be used for determining the condition of the hydraulic system for predictive maintenance purposes and it acts as contamination migration safe guard in between individual air vehicles by indicating contamination in the fluid of the test stand. Application of on-line particle counters for fault finding is also studied extensively.

### 13.2.7 Engine integrity

For engine integrity, the second phase of experimental research activity on Hornet high pressure turbine (HPT) blades has commenced in 2010. During the writing of this review, the research tasks of measuring the operating temperatures of the turbine blades and defining crack growth rate and crack lifing are being done. The annealing experiments of the turbine blade material have been commenced and are still in process. The microstructural changes have been documented (light optical microscopy and scanning electron microscopy) as the annealing experiments are completed. These documented images will be used later for determining the crack age from the turbine blades removed from the service.

The turbine blades are also being FE modeled. The fatigue testing equipment of the turbine blades is ready once the load control software is updated. The other tasks will be commenced during 2011. These tasks will include demonstrating a new NDE method for inspecting the leading edge of the HPT blades based on eddy current technique and making a compendium of reference pictures of used turbine blades to be used in visual inspection, covering various types of cracks and surface damage.

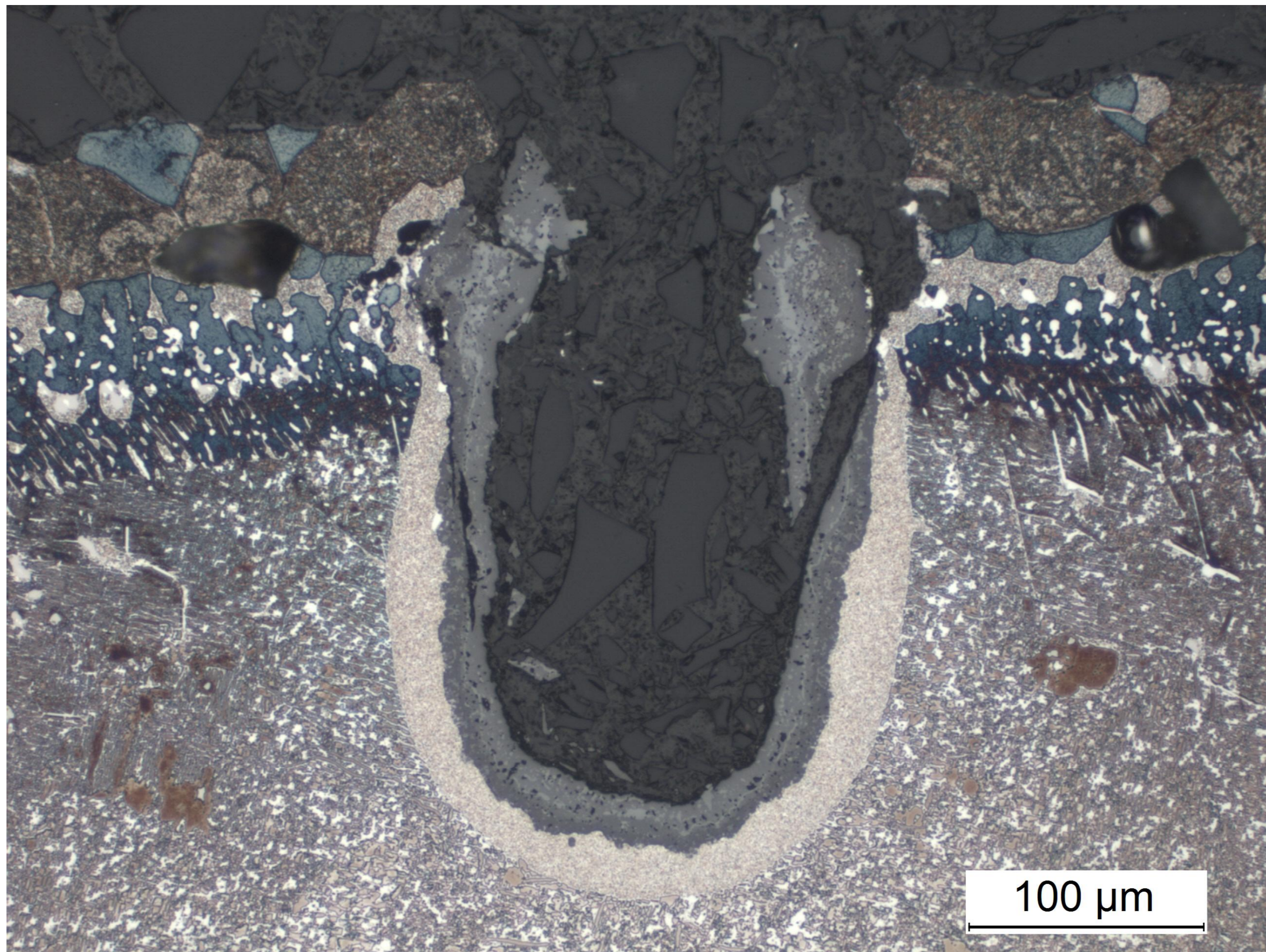

**Figure 27:** *Gamma prime ( $\gamma'$ ) depleted zone and microstructural changes in the base material and in the diffusion zone below the coating in a wire eroded sample annealed at 1050 °C. Picture by courtesy of VTT.*

### 13.3 Related activities

#### 13.3.1 From one-seater to two-seater successfully modified (HN-468) but then lost

The modification from a one-seater into a two-seater was reported in ICAF 2009 Chapter 13.3.1. The challenging four year project in co-operation with (in alphabetical order) Boeing, FINAF, L3 MAS, Patria and US Navy to combine a Canadian F-18B forward fuselage with the single-seat F-18C damaged in a mid-air collision in 2001 was completed in the end of 2009. The modification work was performed by Patria.

The rebuild aircraft was destroyed in an accident on 21 January 2010. The sequence of events in the air led to the impact with terrain of the rebuild F-18D Hornet (Finnish military registration HN-468) and the aircraft was completely destroyed. The probable cause of the accident was a stabilator servocylinder failure during a tailslide maneuver and attempts to restore the normal flight control system operation failed.

The investigation showed no connection between the rebuild and the servo cylinder failure / 6/.

#### 13.3.2 Environmentally friendly corrosion protection studies

Currently much of corrosion protection for aluminium, magnesium and steel is based on hexavalent chromium passivation and cadmium substances. These substances are considered as very toxic ( $T^+$ ) substances by REACH and IPPC directive. The ECOCOAT project (Environmentally Compliant Coatings in Aeronautic) / 20, Chapter 13.3.2/ is aimed at developing alternatives for those priority hazardous substances to be banned in surface treatments. Cooperation is focused on field which still requires research and technology activities for defence

equipment, aiming at developing environmentally compliant surface protection (materials and processes) for durability in severe environments (e.g. marine, runway de-icing).

The following two protection ways need to be replaced or gradually limited:

- Cadmium coatings for mechanical parts, fasteners, bolts, nuts;
- Hexavalent chromium passivation for corrosion resistance of aluminium and/or magnesium alloys with chemical conversion coatings, anodizing and its sealing processes and primers.

The ECOCOAT project (duration 3 years) is being conducted under the auspices of EDA (European Defence Agency). Several EU research partners take part in the project: France (Eurocopter, Safran Group, Dassault Aviation, MBDA France, DGA Aeronautical Systems), Germany (WIWEB, EADS Innovation Works, Cassidian Air Systems), Italy (Centro Sviluppo Materiali) and Finland (the FINAF, VTT, TTY, Patria, Millidyne). The findings of the ECOCOAT project will be validated in industrial contexts and potential industrial application. Economic and environmental impacts will be analyzed so as to ensure that the proposed solutions can be taken up by the European defence industry.

The Finnish consortium within the ECOCOAT project is lead by VTT. Other Finnish partners involved are Tampere University of Technology (TUT), Patria Aviation Ltd and Millidyne Ltd. The Finnish consortium is involved in work related to protection and replacement of cadmium plating for mechanical parts as well as replacement of Cr(VI) conversion coatings on magnesium. The main objective is to develop and investigate the use of sol-gel based hybrid coating materials for both metal substrates. The coating materials should provide corrosion protection against runway de-icing chemicals as well as seawater environment. After the evaluation of the properties of the developed coatings, the coating's performance will be demonstrated in actual aeronautical components.

Recently VTT and Millidyne have prepared several different sol-gel based hybrid coatings on cadmium plated steel. The coatings are targeted to be applied on substrate at either industrial process or touch-up. Therefore, the easy-to-apply methods as well as low-temperature or radiation curing are preferred. The coated samples have been tested with AMS G-12 corrosion test by focusing on surface exposure of runway de-icing chemicals (AMS G-12 corrosion test is a corrosion test for cadmium). The test has been developed by AMS Working Group G12, and the corrosion test will be included in the standards AMS 1435 and 1431. In addition, the samples have been characterised with scanning electron microscopy (SEM). So far promising results have been obtained for supplementary protection of cadmium. The research will continue until to 2013.

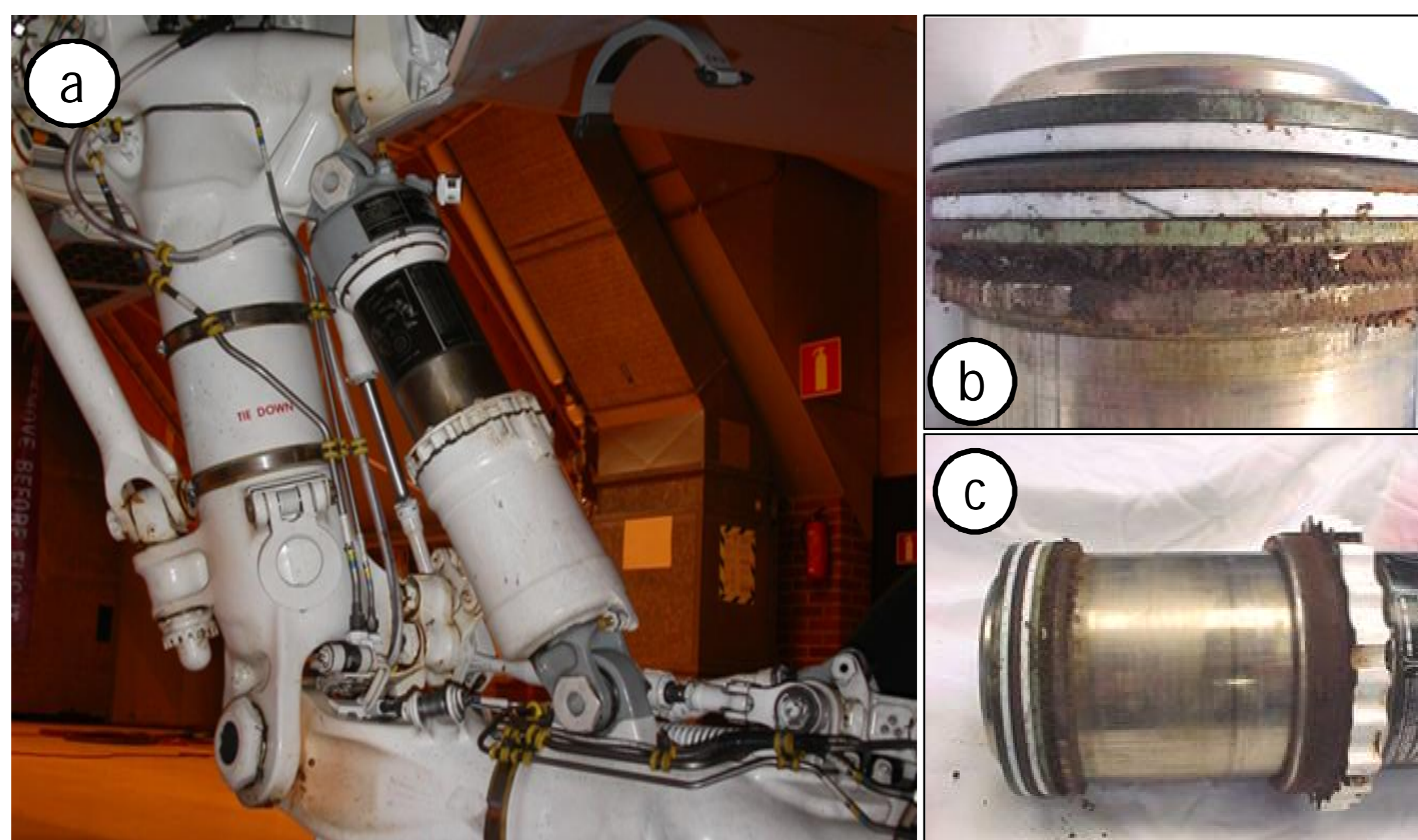

**Figure 28:** Corrosion is often found from the internal areas of the main landing gear (a) components of the FINAF F-18, such as the piston of the shock absorber (b) and the piston rod (c). The corrosion products harmfully scratch the gliding surfaces such that these expensive and long lead time items must be removed from service. Picture by courtesy of the FINAF.

## 13.4 References

- / 1/ Aaltonen, J.; Koskinen, K. T.; Vilenius, M.; Vaaraniemi, K. 2007. *Pump supply pressure fluctuations in the Semiclosed hydraulic circuit with bootstrap type reservoir*. The 10<sup>th</sup> Scandinavian International Conference on Fluid Power, Tampere, Finland, 2007.
- / 2/ Aaltonen, J.; Koskinen, K. T.; Vilenius, M.; Vaaraniemi, K. 2007. *Hydraulic fluid quality in aircraft hydraulic systems*. The 10<sup>th</sup> Scandinavian International Conference on Fluid Power, Tampere, Finland, 2007.
- / 3/ Bäckström, M.; Liukkonen, S.; Laakso, R.; Viitanen, T.; Koski, K.; Teittinen, T. 2009. *OLM/HOLM ground analysis environment. Version 3*. Report № VTT-R-06669-08 / 31.12.2009. Espoo: VTT Technical Research Centre of Finland (in Finnish).
- / 4/ FINAF 2011. The Finnish Air Force: *Introducing Finnish Military Aircraft from the Past to the Present* ([http://www.puolustusvoimat.fi/en/Air\\_Force/](http://www.puolustusvoimat.fi/en/Air_Force/), reference: April 2011).
- / 5/ FINAF 2011. The Finnish Air Force ([http://www.puolustusvoimat.fi/en/Defence\\_Forces/News/](http://www.puolustusvoimat.fi/en/Defence_Forces/News/), reference: April 2011).
- / 6/ FINAF 2011. Failure of Flight Control System Servocylinder Cited as Probable Cause of F-18 Accident ([http://www.puolustusvoimat.fi/en/Air\\_Force/Front\\_Page/](http://www.puolustusvoimat.fi/en/Air_Force/Front_Page/), reference: April 2011).
- / 7/ Haapaniemi, M. 2007. *NH90 ground testing tree* (Engineering Thesis). Tampere Polytechnic, Mechanical and Production Engineering, Aeronautical Engineering. November 2007 (<https://publications.theseus.fi/bitstream/handle/10024/8753/Haapaniemi.Mikko.pdf?sequence=2>, reference: April 2011).
- / 8/ Hietala, J. P. 2008. *Modeling and simulation of an aircraft rudder servoactuator*. Master of Science Thesis, Tampere: Tampere University of Technology, 2008.
- / 9/ Hietala, J. P.; Aaltonen, J.; Koskinen, K. T.; Vilenius, M. 2009. *Modeling and simulation of the aircraft rudder hydraulic servo actuator with dynamic interconnections to flight dynamics and flight control system models*. SICFP'09 Proceedings, the 11th Scandinavian International Conference on Fluid Power, Linköping, Sweden, June 2-4 2009 12 p.
- / 10/ Hintikka, P. 2009. *Determination of Fracture Mechanic Properties for Composite Laminates*. Helsinki University of Technology, Aeronautical Engineering, Master's Thesis, 2009 (in Finnish).
- / 11/ Hintikka, P. 2010. *Biaxial testing of composite laminates*. Aalto University, School of Engineering, Department of Applied Mechanics, Aeronautical Engineering, report KRT-T350, 2010, 27 p. (in Finnish).
- / 12/ Hintikka, P.; Wallin, M.; Saarela, O. 2010. *Effect of Moisture on the Interlaminar Fracture Toughness of CFRP Laminate*. International Council of the Aeronautical Sciences, 27<sup>th</sup> Congress 2010, 19-24 September 2010, Nice, France.
- / 13/ Hukkanen, T. 2010. *F-18 Structural Integrity Management Plan, Part I: Structural Integrity*. Report № HN-L-0172 Rev. A. Patria Aviation, Halli, Finland (in Finnish, classified).
- / 14/ Hukkanen, T. 2010. *F-18 Structural Integrity Management Plan, Part II: Structural Maintenance Plan*. Report № HN-L-0173 Rev. A. Patria Aviation, Halli, Finland (in Finnish, classified).
- / 15/ Hämäläinen, M. 2007. *Modeling and simulation of an aircraft leading edge flap actuator*. Master of Science Thesis, Tampere: Tampere University of Technology, 2007 (in Finnish).
- / 16/ ICAF 2001. *A review of recent aeronautical fatigue investigations in Finland until March 2001*. Research Report № BVAL33-011139/AOS (A. Siljander, Ed.). Espoo: VTT Manufacturing Technology, Maritime and Mechanical Engineering. June 2001. Available at: [http://www.vtt.fi/inf/julkaisut/muut/2001/icafe\\_2001\\_finland\\_review.pdf](http://www.vtt.fi/inf/julkaisut/muut/2001/icafe_2001_finland_review.pdf) (reference: April 2011).
- / 17/ ICAF 2003. *A review of aeronautical fatigue investigations in Finland during the period February 2001 to March 2003*. Research Report № BTUO33-031123 (A. Siljander, Ed.). Espoo: VTT Industrial Systems, Product Performance. April 29, 2003. Available at: [http://www.vtt.fi/inf/julkaisut/muut/2003/icafe\\_2003\\_finland\\_review.pdf](http://www.vtt.fi/inf/julkaisut/muut/2003/icafe_2003_finland_review.pdf) (reference: April 2011).

- / 18/ ICAF 2005. *A review of aeronautical fatigue investigations in Finland during the period April 2003 to April 2005*. Research Report № BTUO33-051366 (A. Siljander, Ed.). Espoo: VTT Industrial Systems. June 2, 2005. Available at: [http://www.vtt.fi/inf/julkaisut/muut/2005/icaf\\_2005\\_finland\\_review\\_issue1.pdf](http://www.vtt.fi/inf/julkaisut/muut/2005/icaf_2005_finland_review_issue1.pdf) (reference: April 2011).
- / 19/ ICAF 2007. *A review of aeronautical fatigue investigations in Finland during the period May 2005 to April 2007*. (A. Siljander, Ed.). ICAF Document № 2410 (VTT Research Report № VTT-R-03406-07). Espoo: VTT Industrial Systems. April 25, 2007. Available at: [http://www.vtt.fi/inf/julkaisut/muut/2007/ICAF\\_FinlandReview\\_2007.pdf](http://www.vtt.fi/inf/julkaisut/muut/2007/ICAF_FinlandReview_2007.pdf) (reference: April 2011).
- / 20/ ICAF 2009. *A review of aeronautical fatigue investigations in Finland during the period May 2007 to April 2009*. (A. Siljander, Ed.). ICAF Document № 2418 (VTT Research Report № VTT-R-02540-09). Espoo: VTT Industrial Systems. April 4, 2009. Available at: [http://www.vtt.fi/inf/julkaisut/muut/2009/ICAF\\_Doc2418.pdf](http://www.vtt.fi/inf/julkaisut/muut/2009/ICAF_Doc2418.pdf) (reference: April 2011).
- / 21/ Janhunen, H. 2009. *F-18 Hornet; Identifying the most damaging flight maneuvers; Part I*. Report № VTT-R-08804-09 / 17.12.2009. Espoo: VTT Technical Research Centre of Finland (in Finnish, classified).
- / 22/ Janhunen, H. 2009. *Visualization of the damaging flight maneuvers of Hawk horizontal tail*. Report № VTT-S-09492-09 / 30.12.2009. Espoo: VTT Technical Research Centre of Finland (in Finnish, classified).
- / 23/ Janhunen, H. 2009. *Flight Analyzer v2.0 manual and the visualization tool*. Report № VTT-R-09491-09 / 31.12.2009. Espoo: VTT Technical Research Centre of Finland (in Finnish, classified).
- / 24/ Janhunen, H. 2010. *Trends in the fatigue tracking of HN-flights 1/2010*. Report № VTT-R-03252-10 / 19.5.2010. Espoo: VTT Technical Research Centre of Finland (in Finnish, classified).
- / 25/ Janhunen, H. 2010. *The search of the most damaging flight maneuvers with AMANA-software and the verification and validation of the software*. Report № VTT-R-09274-10 / 13.12.2010. Espoo: VTT Technical Research Centre of Finland (in Finnish, classified).
- / 26/ Jokinen, J. 2009. *Numerical modeling of delaminations*. Helsinki University of Technology, Aeronautical Engineering, Master's Thesis, 2009 (in Finnish).
- / 27/ Jokinen, J. 2009. *Delamination modeling using cohesive elements*. Aalto University, School of Engineering, Department of Applied Mechanics, Aeronautical Engineering, report KRT-T346, 2009, 64 p. (in Finnish).
- / 28/ Jokinen, J. 2010. *Effect of interfaces and analysis parameters on 1D damage modeling*. Aalto University, School of Engineering, Department of Applied Mechanics, Aeronautical Engineering, report KRT-T364, 2010, 45 p. (in Finnish).
- / 29/ Jokinen, J. 2011. *Analysis of a symmetric 1D damage*. Aalto University, School of Engineering, Department of Applied Mechanics, Aeronautical Engineering, report KRT-T363, 2011, 64 p. (in Finnish).
- / 30/ Jylhä, J.; Ruotsalainen, M.; Salonen, T.; Janhunen, H.; Viitanen, T.; Vihonen, J. and Visa, A. 2009. *Towards automated flight-maneuver-specific fatigue analysis*. In: Bridging the Gap between Theory and Operational Practice, Proceedings of the 25<sup>th</sup> ICAF Symposium, pp. 1121-1134. Bos, M. J. (Ed.), Rotterdam, the Netherlands.
- / 31/ Jylhä, J.; Ruotsalainen, M.; Salonen, T.; Janhunen, H.; Venäläinen, I.; Siljander, A. 2011. *Link between flight maneuvers and fatigue*. ICAF 2011 oral presentation.
- / 32/ Jylhä, J.; Vihonen, J.; Ala-Kleemola, T.; Kerminen, R.; Tikka, J.; Visa, A. 2007. *Modelling structural vibrations for automated aircraft fatigue monitoring*. In: Durability and Damage Tolerance of Aircraft Structures: Metals vs. Composites, Proceedings of the 24th ICAF Symposium, pp. 1031-1042. Lazzeri, L.; Salvetti, A (Eds.), Naples, Italy.
- / 33/ Kettunen, J. 2010. *BAe Hawk Structural Integrity Management Plan, Part I: Structural Integrity*. Report № HW-L-0104 Rev. A. Patria Aviation, Halli, Finland (in Finnish, classified).
- / 34/ Kettunen, J. 2010. *BAe Hawk Structural Integrity Management Plan, Part II: Structural Maintenance Plan*. Report № HW-L-0105 Rev. A. Patria Aviation, Halli, Finland (in Finnish, classified).



- / 35/ Koski, K.; Juntunen, J.; Sarkimo, M.; Laakso, R.; Merinen, S.; Teittinen, T.; Pitkänen, I. 2009. *Fatigue tests of the machined aluminum test specimens, version 2*. Report № VTT-R-04456-09 / 15.6.2009. Espoo: VTT Technical Research Centre of Finland (in Finnish, classified).
- / 36/ Koski, K.; Laakso, R.; Merinen, S.; Sarkimo, M.; Leskelä, E.; Juntunen, J.; Teittinen, T. 2011. *Fatigue tests of aluminum alloy test specimens*. Report № VTT-R-02004-11 / 18.3.2011. Espoo: VTT Technical Research Centre of Finland (in Finnish, classified).
- / 37/ Koski, K.; Peltoniemi, E.; Laakso, R. 2010. *Fatigue analysis of the bulkhead structure*. Report № VTT-R-03582-10 / 20.5.2010. Espoo: VTT Technical Research Centre of Finland (classified).
- / 38/ Laakso, R.; Koski, K.; Viitanen, T.; Peltoniemi, E. 2009. *HOLM structural details; Hornet's structural locations for the damage calculations within the HOLM ground analysis environment; Part 3*. Report № VTT-R-02080-09 / 2.11.2009. Espoo: VTT Technical Research Centre of Finland (in Finnish, classified).
- / 39/ Laatikainen, Y.; Linna, J. 2009. *F-18 Bulkhead Y488 heating tests for the boron fiber patch*. Report № HN-L-0174, 24.11.2009. Patria Aviation, Halli, Finland (in Finnish, classified).
- / 40/ Lahdenperä, K.; Leskelä, E.; Siljander, A. 2010. *Experimental study of the sensitivity of the crack detection techniques applicable in the periodic in-service inspections using reference specimens*. Report № VTT-R-04012-10 / 18.5.2010. Espoo: VTT Technical Research Centre of Finland.
- / 41/ Lahdenperä, K.; Leskelä, E. 2011. *Experimental study of the sensitivity of the crack detection techniques applicable in the periodic in-service inspections using unpainted and painted test specimen with real fatigue cracks*. Report № VTT-R-10255-10 / in progress. Espoo: VTT Technical Research Centre of Finland.
- / 42/ Liius, M. 2009. *HT Spindle detailed FE model*. Report № HN-L-0169. Patria Aviation, Halli, Finland (in Finnish).
- / 43/ Liius, M. 2010. *Inner Wing Fold Rib detailed FE model*. Report № HN-L-0187. Patria Aviation, Halli, Finland (in Finnish).
- / 44/ Linna, J. 2007. *Effect of surface working methods on the fatigue life of 7050-T7451 aluminum alloy using stress ratio  $R = 0,3$* . Report № HN-L-0124. Patria Aviation, Halli, Finland (in Finnish, classified).
- / 45/ Linna, J. 2007. *Effect of chromic and phosphoric acid anodizing on the fatigue life of 7075-T76 and 7075-T6 Al alloys*. Report № HN-L-0139. Patria Aviation, Halli, Finland (in Finnish, classified).
- / 46/ Linna, J. 2010. *Test plan for additional F-18 material coupon testing*. Report № HN-L-0186. Patria Aviation, Halli, Finland (in Finnish, classified).
- / 47/ Linna, J. 2011. *Results of shot peening and polishing on the fatigue life of 6Al-4V titanium alloy*. Report № HN-L-0194. Patria Aviation, Halli, Finland (in Finnish, classified).
- / 48/ Linna, J. 2011. *Results of Clad Al 7075-T6 and alodine chromate conversion treated Al 7075-T76 fatigue tests*. Report № HN-L-0195. Patria Aviation, Halli, Finland (in Finnish, classified).
- / 49/ Liukkonen, S. 2009. *HW OLM UG2: Plan to upgrade the OLM onboard data acquisition system*. Report № VTT-R-08813-09 / 30.11.2009. Espoo: VTT Technical Research Centre of Finland (in Finnish, classified).
- / 50/ Malmi, S.; Orpana, M. 2010. *The g counter status of the Vinkas – 12/2010*. Report № Leko-70X F-108 / 17.12.2010. Patria Aviation (in Finnish, classified).
- / 51/ Orpana, M. 2009. *HT Bootstrap detailed FE model*. Report № HN-L-0168. Patria Aviation, Halli, Finland (in Finnish).
- / 52/ Patria Focus 2/2009. In-house magazine. Available at: [http://patria.smartpage.fi/focus/en209/pdf/Patria\\_Focus\\_209\\_EN.pdf](http://patria.smartpage.fi/focus/en209/pdf/Patria_Focus_209_EN.pdf) (reference: April 2011).
- / 53/ Patria 2011. Press release 14 January 2011: *Patria Received a Significant Order for MLU2 series installations for the Finnish Air Force*. Available at: [http://www.patria.fi/patria\\_www\\_en\\_sisalto/patria\\_www\\_en/news+and+info/press+releases+and+news/patria+received+a+significant+order+for+mlu2+series+installations.html](http://www.patria.fi/patria_www_en_sisalto/patria_www_en/news+and+info/press+releases+and+news/patria+received+a+significant+order+for+mlu2+series+installations.html) (reference: April 2011).

- / 54/ Peltoniemi, E.; Janhunen, H. 2010. *A study of how to integrate external stores into the F-18C flight simulation model*. Report № VTT-R-00398-10 / 15.2.2010. Espoo: VTT Technical Research Centre of Finland (in Finnish, classified).
- / 55/ Peltoniemi, E.; Koski, K.; Laakso, R. 2009. *Estimating the structural fatigue life consumption in flight sorties for Kauhava-based Hawks and defining the consumption metrics in the tailplane*. Report № VTT-R-09940-09 / 31.12.2009. Espoo: VTT Technical Research Centre of Finland (in Finnish).
- / 56/ Peltoniemi, E.; Viitanen, T. 2010. *Determining the cut-off frequencies for HOLM strain gauge signals to be used in the VTT's ground station*. Report № VTT-R-07674-10 / 11.1.2010. Espoo: VTT Technical Research Centre of Finland (in Finnish, classified).
- / 57/ Renko, K. 2011. Private communication (19 February 2011).
- / 58/ Ruotsalainen, M.; Jylhä, J.; Vihonen, J.; Visa, A. 2009. *A novel algorithm for identifying patterns from multisensor time series*. In: Proceedings of the 2009 WRI World Congress on Computer Science and Information Engineering (CSIE 2009), IEEE, pp. 100-105, Los Angeles, USA.
- / 59/ Saarimäki, E.; Ylinen, P. 2009. *Development of thermographic inspection routine exploiting phase transition of water for moisture detection in aircraft structures*. Proceedings of SPIE – The International Society for Optical Engineering. Thermosense XXXI. Vol. 7299 (2009), № XXXI, 729911-1-729911-9 ICT.
- / 60/ Siikonen, T.; Rautaheimo, P.; Salminen, E. 2000. *Numerical Techniques for Complex Aeronautical Flows*. European Congress on Computational Methods in Applied Sciences and Engineering. Barcelona, Spain, Sept. 11-14, 2000.
- / 61/ Siikonen, T.; Salminen, E.; Ilkko, J. 2010. *Simulation of a Helicopter Rotor Flowfield*. FINFLO technical reports F-62 (in Finnish).
- / 62/ Siljander, A.; Laakso, R. 2009. *HW OLM UG2: The plan for the aircraft instrumentation and ground system procedures*. Report № VTT-R-08509-09 / 30.11.2009. Espoo: VTT Technical Research Centre of Finland (in Finnish, classified).
- / 63/ Tikka, J.; Salonen, T. 2007. *Parameter Based Fatigue Life Analysis of F18 Aircraft*. Durability and Damage Tolerance of Aircraft Structures: Metals vs. Composites. Proceedings of the 24<sup>th</sup> Symposium of the International Committee on Aeronautical Fatigue (ICAF), Naples, Italy, 16-18 May 2007. Volume I (lecture papers; L. Lazzeri & A. Salvetti, Eds.) pp 412-426.
- / 64/ Viitanen, T.; Janhunen, H. 2009. *Simulation of external store separation from an aircraft; Part 2*. Report № VTT-R-06708-09 / 9.10.2009. Espoo: VTT Technical Research Centre of Finland (in Finnish).
- / 65/ Viitanen, T.; Janhunen, H. 2010. *HOLM: the analysis of two comparative flights of HN-432*. Report № VTT-R-01496-10 / 19.3.2010. Espoo: VTT Technical Research Centre of Finland (in Finnish, classified).
- / 66/ Viitanen, T.; Laakso, R.; Merinen, S.; Peltoniemi, E. 2009. *F-18 Hornet: Fatigue tracking results of the aircraft HN-416 and HN-432 using VTT's ground station – semi-annual report (IV/2009)*. Report № VTT-R-07125-09 / 30.11.2009. Espoo: VTT Technical Research Centre of Finland (in Finnish, classified).
- / 67/ Viitanen, T.; Laakso, R.; Janhunen, H.; Merinen, S. 2009. *HOLM fatigue analysis database, HOLM\_BASE v2.0.0*. Report № VTT-R-03030-09 / 9.11.2009. Espoo: VTT Technical Research Centre of Finland (in Finnish, classified).
- / 68/ Viitanen, T. 2010. *HOLM: Electrical calibration of HN-416*. Report № VTT-R-00397-10 / 13.4.2010. Espoo: VTT Technical Research Centre of Finland (in Finnish, classified).
- / 69/ Viitanen, T. 2010. *HOLM: Electrical calibration of HN-432*. Report № VTT-R-02544-10 / 13.4.2010. Espoo: VTT Technical Research Centre of Finland (in Finnish, classified).
- / 70/ Viitanen, T. 2009. *Trim routine development of the F-18C Hornet aircraft model for the HUTFLY2 flight simulation software*. Report № VTT-R-09017-09 / 18.12.2009. Espoo: VTT Technical Research Centre of Finland (in Finnish, classified).

- / 71/ Viitanen, T. 2011. *Updated trim routine of the F-18C Hornet aircraft model for the HUTFLY2 flight simulation software*. Report № VTT-R-00842-11 / 4.3.2011. Espoo: VTT Technical Research Centre of Finland (in Finnish, classified).
- / 72/ Virta, P.; Aaltonen, J.; Koskinen, K. T.; Vilenius, M. 2009. *Experiences on the condition monitoring of military aircraft hydraulic systems*. The Sixth International Conference on Condition Monitoring and Machinery Failure Prevention Technologies, Dublin, Ireland, 23-25 June 2009 pp. 753-764.
- / 73/ Virta, P.; Aaltonen, J.; Koskinen, K. T.; Vilenius, M. 2010. *Experiences of monitoring the condition of military aircraft hydraulic systems*. Condition Monitor, An International Newsletter 280, pp. 9-14.
- / 74/ Wallin, M.; Saarela, O. 2008. *Compression strength of notched and impact damaged composite laminates*. International Council of the Aeronautical Sciences, 26<sup>th</sup> Congress 2008, 9 p. 14-19 September 2008, Anchorage, Alaska.
- / 75/ Wallin M. 2010. *Impact damaged laminates in multiaxial stress state*. Aalto University, School of Engineering, Department of Applied Mechanics, Aeronautical Engineering, report KRT-T349, 2010, 57 p. (in Finnish).
- / 76/ Wallin M.; Saarela, O. 2010. *Analysis and Tests of Impact Damaged Symmetric and Balanced Laminates*. International Council of the Aeronautical Sciences, 27<sup>th</sup> Congress 2010, 9 p. 19-24 September 2010, Nice, France.
- / 77/ White, P.; Molent, L.; Barter, S. *Interpreting fatigue test results using a probabilistic fracture approach*. International Journal of Fatigue 27(2005)7, pp. 752-767.
- / 78/ Öström, J.; Hiirsalmi, M.; Ahola, J. 2007. *PV-TEKNO, Phase 2*. Research Report № VTT-R-02101-07. Espoo: VTT Technical Research Centre of Finland (in Finnish, classified).
- / 79/ Öström, J.; Viitanen, T.; Janhunen, H. 2009. *Postprocessor development for the HUTFLY2 flight simulation software*. Report № VTT-R-09016-09 / 18.12.2009. Espoo: VTT Technical Research Centre of Finland (in Finnish, classified).

Report's title	
A REVIEW OF AERONAUTICAL FATIGUE INVESTIGATIONS IN FINLAND MAY 2009 – MARCH 2011	
Customer, contact person, address	
The Finnish Air Force Materiel Command Programmes Division Mr. Ari Välikangas P. O. Box 14; FI-41161 Tikkakoski; Finland	
Project name	
75291 - ICAF 2011	
Editors	Pages
Enna Peltoniemi; Aslak Siljander	42/
Keywords	Report identification code
Aeronautical fatigue, military aircraft, fixed wing, research project, structural integrity, Finland	ICAF Doc № 2427 / 5.4.2011 (VTT-R-02827-11 / 12.4.2011)
Summary	
<p>This document was prepared for the delivery to the 32<sup>nd</sup> Conference of the International Committee on Aeronautical Fatigue and Structural Integrity scheduled to be held in Montréal, Canada on 29-31 May 2011.</p> <p>A review is given of the aircraft structural fatigue research and associated activities which form part of the programs within the Finnish Air Force Materiel Command (FINAFMC): Programmes Division, Plans Division and Aircraft Division; Patria Aviation Oy, VTT Technical Research Centre of Finland (VTT), Aalto University (Aalto), Tampere University of Technology Institute of Signal Processing (TUT/ISP) and Department of Materials Science (TUT/DMS), Finflo Ltd, Emmecon Ltd and Millidyne Ltd.</p> <p>The review summarizes fatigue related research programs and investigations on specific military fixed wing aircraft since the previous Finnish National Review (tabled in the 31<sup>st</sup> Conference, ICAF, Rotterdam, the Netherlands) up to March 2011.</p>	
Confidentiality	Public
Espoo 26.4.2011	
Approved by	
Aslak Siljander ICAF National Delegate / Finland (VTT)	
Editors' contact address	
VTT, P. O. Box 1000, FI-02044 VTT, Finland (Street: Vuorimiehentie 3, Espoo, Finland)	
Distribution	
Unclassified. Distribution unlimited. This document has been authorized by the FINAFMC for unlimited public release [Permission № 205/25.07/2010 – CH6895 dated 26 <sup>th</sup> April 2011].	